

MAX Count 6 and 6S Advanced
 16 PRESET COUNTER (Count 6)
 SEQUENTIAL 16 PRESET COUNTER (Count 6S)
 with BATCHING and TOTALIZER



'MAX Count 6 Advanced' & 'MAX Count 6S Advanced' are powerful sixteen preset (*Sequential) Counter with a presettable Batch Counter and a Background Totalizer. MAX features guided programming using English prompts for easy setup and operation. MAX is clearly the best choice for Industrial counting applications.

FEATURES

- Simultaneous Counter, Totalizer, and Batching
- "ON THE FLY" Preset Programming
- A-B, A+B and Quadrature operation
- Sixteen Preset, Six Decade Main Counter
- Single Preset, Six Decade Batch Counter
- Six Decade Background Totalizer
- 4 Wire / 2 Wire RS-485 Provides LOCAL & REMOTE process Control Capability with Modbus RTU protocol
- Six Decade Start Count Preset
- Counter Reset, Stop / Hold / (*Step Back) Inputs
- *Automatic and Manual Preset Sequencing
- *Common Early Warn Preset Programming
- Batch / Total / (*Cycle Reset) Reset input
- Output Control (*Step Forward) input
- Non-Volatile Memory (FRAM) for Counters & Programmed parameters
- Built In Self- Diagnostics
- Eight Alpha Numeric, 14 Segments LED display

KEY SPECIFICATIONS

- DC to 20kHz Operation (10 kHz max. input frequency x2; 5 kHz Input Frequency x4)
- 16 Presets with 'ON' and 'OFF' selection
- Five Decade Calibrator
- Seven (*Eight) Open collector Transistor Outputs
- *Three Programmable Inputs provide Eight Functions
- Programmable Output Hold Time xx.xx sec
- +12VDC @ 175mA Transducer Supply
- 85-265 VAC Operation (12VDC Optional)

*** Applies to MAX Count 6S only**

INDEX TO CONTENTS

Overview	p. 2,3
Specification	p. 4
Front Panel Controls	p. 5
Programming	p. 6 - 13
Operation	p. 14 - 17
Applications	p. 18 - 21
Installation	p. 22 - 24
Serial Communication Overview	p. 25
Serial Interface Protocol	p. 26 - 37
Ordering Information	p. 38



Eagle Signal



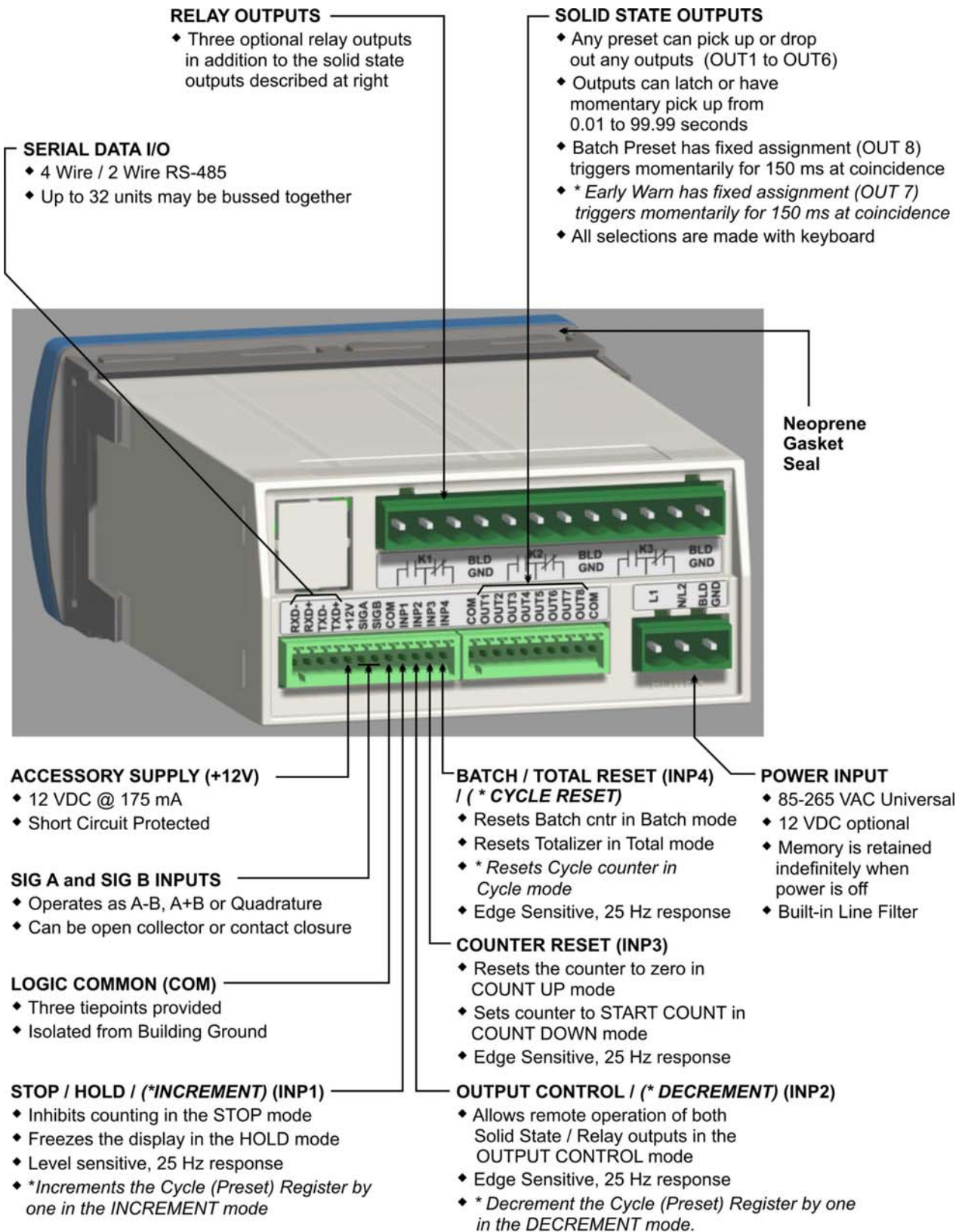

*** Applies to MAX Count 6S only**

Input Power: 85-265 VAC, 50-60Hz, 20 VA
12 VDC @ 0.5 A. Optional

Accessory Supply: 12 VDC @ 175 mA.

Main Counter:
Range: 6 Decades
Presets: 16 Individual with 6 decade range and 'ON', 'OFF' selection
** Pre warn:* Single six decade preset applied "above" and "below" the active preset. (Common to all presets)
Operation: A-B, A+B, Quadrature
Reset Input: External and front panel
Count Rate:
Open collector: 20 kHz internal (20 kHz external input frequency with x1 logic) (10 kHz; x2 logic) (5 kHz; x4 logic)
Contact Closure: 25Hz max. (With x1 logic)

Calibrator:
Range: 5 Decade, 0.0001 to 9.9999
Operation: Calibrates Main Counter and Totalizer

** Cycle Counter:* Two decade (1-16) indicating currently active preset

Totalizer:
Range: 6 Decade
Operation: Totalizes calibrated input counts

Batch Counter:
Range: 6 Decade
Presets: 1 with 6 Decade range
Operation:
Max Count 6 Count UP by detecting Auto resets of main counter.
Max Count 6S Count UP by detecting last preset processed (Highest order).
Output: Fixed assignment (150 ms)

Signal A and B Inputs:
Input Frequency: DC to 20 kHz max. (20 kHz external input frequency with x1 logic) (10 kHz; x2 logic) (5 kHz; x4 logic)
Input Type: Single ended, Current Source
Input Logic: Programmable
Input High Level: 3.25 VDC min.
Input Low Level: 1.75 VDC max.
Input Impedance: 1.0 kΩ to common
Input current: 3.25mA. steady state
Input Response: 10µs. min high and low time

Control Inputs:
Input Frequency: DC to 25Hz Max. each input.
Input Type: Single ended, current sinking
Input Logic: Both edge & Level sensitive as defined by input use
Input High Level: 10VDC min. to 20 VDC max.
Input Low Level: 0 VDC min. to 2 VDC max.
Input Impedance: 4.7 kΩ pullup to +12 Vdc
Input Current: 2.5 mA. Steady state
Input Response: 25 ms. make and break time

Display:
Decades: Eight Alpha Numeric, 0.4" red LED
Annunciators: Eight Annunciators RUN, SET, PGM, PST, ON, OFF, OUT, AUTO
Decimal Point: User programmable
Range: xx.xxxx to xxxxxx

Keyboard: Sealed tactile feel, 6 positions

Program Security: LOCK for PROGRAM mode menu and Preset Lock in Setup mode.

Control Outputs:
Type: Seven (* Eight) Solid State 100mA sink @ 24 VDC max.
Assignment: Outputs 1-6 have programmable assignment (OUT 1 to OUT6) to presets. They may latch or trigger momentarily. The * Early warn (OUT7) and Batch (OUT8) outputs have fixed momentary times of 150ms.
Optional: 3 SPDT Relays, rated 10Amp 30VDC/120VAC Resistive
3.5 Amp 120VAC Inductive (0.8pf)
3 Amp 240VAC resistive

Serial Interface:
Type: RS-485 compatible (4 or 2 wire options with modbus support)
Baud Rate: Selectable; OFF,1200, 2400, 4800 or 9600
Data: Binary
Format: 1 START Bit, 8 Bit data , 1 STOP Bit
Protocol: ModBus RTU
I.D. Number: Programmable 01 to 32: Allows multidrop systems.

Diagnostics:
Test 0: Keyboard Test
Test 1: FRAM Test
Test 2: Input Test
Test 3: Output Test
Test 4: Display Test
Test 5: Date Code Test
Test 6: Serial I/O Test
Test 7: Return to Factory Programming

Mechanical:
Enclosure: Plastic Moulded
2.0" High x 4.0 Wide x 5.56" Deep
Cutout: 1.77"[45mm] x 3.62" [92mm]
Panel Thickness: 1/16" to 1/4"
Panel Depth: 5.68" Minimum
Weight: 0.68 lb [308 gm]

Environmental:
Operating Temp: -15°C to +65°C
Storage Temp: -30°C to +85°C
Ambient Humidity: 90% and noncondensing

Controller Error Codes
1. Low AC Line Voltage (Displays LOW AC)
2. Input Frequency Too fast (Displays FREQ MAX)

 Press **RST CLR** To clear Error Code

FRAM Error Codes
1. Run Mode parameters corrupted (FRUNFAIL).
2. Program Mode parameters corrupted (FPGMFAIL).

*** Applies for MAX Count 6S only**

Note: Power cycle to clear the FRAM error

DISPLAY ANNUNCIATORS

- ◆ RUN Indicates RUN mode operation
- ◆ SET Indicates SETUP mode operation
- ◆ PGM Indicates PROGRAM mode operation
- ◆ PST Illuminated for all Preset lines
- ◆ ON Indicates that displayed Preset is enabled
- ◆ OFF Indicates that displayed Preset is disabled
- ◆ OUT Illuminated for output programming
- ◆ AUTO Illuminated for Programmed Auto Reset



DOWN KEY

- ◆ Sequences down through menu options of RUN or SETUP menu
- ◆ Sequences down through menu options of programming menu in the PROGRAM mode
- ◆ Decrement the number in edit mode (Highlighted digit)

UP KEY

- ◆ Sequences Up through menu options of RUN or SETUP menu
- ◆ Sequences Up through menu options of programming menu
- ◆ Increment the number in edit mode (Highlighted digit)

RIGHT KEY

- ◆ Sequences to the right in individual Programming menus or enters edit mode by highlighting the left most digit and sequences highlighting to the right digit in Program menu & in SETUP mode

RESET / CLEAR

- ◆ Reset Main Counter, Batch Counter and Totalizer in the RUN Mode (Lines S,1,2).
- ◆ Affects only the currently displayed line.
- ◆ Clears display in the SETUP and PROGRAM modes
- ◆ * *In Program mode, used to ON, OFF, AUTO RESET the presets*

RUN/PGM

- ◆ Used to switch between the RUN and PROGRAM modes. Acts as an alternate action switch.

KEY

- ◆ Used to enter SETUP mode from the RUN mode.
- ◆ Press again to exit SETUP & go to RUN mode.
- ◆ Allows the unit to be programmed "on the fly". Used to direct address lines while in PROGRAM mode, press KEY, line number, Key

*** Applies to MAX Count 6S only**

RUN MODE:

LINE Number		FUNCTION	DESCRIPTION
MAX Count 6	MAX Count 6S		
S	S	COUNT VALUE	Indicates current Count
1	1	BATCH COUNT VALUE	Indicates current Batch Count
2	2	TOTAL COUNT VALUE	Indicates current Totalizer Count. Conditional: Totalizer parameter must be 'ON' in MENU.
N.A.	3	ACTIVE PRESET	Indicates the currently active preset. P1 through P16.













SETUP MODE:

SETUP MODE (inhibited by the PRESET LOCK being 'ON')



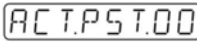

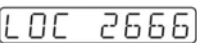

























LINE Number		FUNCTION	DESCRIPTION
MAX Count 6	MAX Count 6S		
3	4	START COUNT	Numeric Value for "set to a number". Conditional display: line direction must be 'Down'
N.A.	5	EARLY WARN PRESET	Numeric value for Early warn preset. Applied "above" and "below" other presets.
4	6	PRESET 1	Numeric value for Preset 1. May be turned 'ON' or 'OFF' with RST/CLR key before entering Edit mode.
5	7	PRESET 2	Numeric value for Preset 2. May be turned 'ON' or 'OFF' with RST/CLR key before entering Edit mode.
6	8	PRESET 3	
7	9	PRESET 4	
8	10	PRESET 5	
9	11	PRESET 6	
10	12	PRESET 7	
11	13	PRESET 8	
12	14	PRESET 9	
13	15	PRESET 10	
14	16	PRESET 11	
15	17	PRESET 12	
16	18	PRESET 13	
17	19	PRESET 14	
18	20	PRESET 15	
19	21	PRESET 16	Numeric value for Preset 16. May be turned 'ON' or 'OFF' with RST/CLR key before entering Edit mode.
20	22	BATCH PRESET	Numeric value for Batch Preset.

N.A. = Not Applicable

RUN MODE

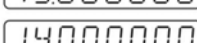
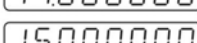
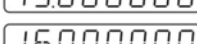
		Current Main counter display			For Menu navigation	
		Current Batch counter display			No Function	
		Current Totalizer counter display			No action if FP. RST in Program mode ON, it resets to Zero)	
		Active preset display (For MAX Count 6S only)			Press KEY to enter SET mode, Annunciator SET glows	
						To enter PROGRAM mode

SETUP MODE

		For MAX Count 6S only	<p> To edit parameters (The selected digit is highlighted);</p> <p> Turn ON or OFF the Preset</p> <p>  For Menu navigation</p> <p> Asks for a line counter LINE 00</p>	<p> and  Increment or Decrement the selected digit</p> <p> Pressing Right arrow key again - the highlighted digit moves from left to right; one digit every time and it is cyclic.</p> <p> To save the value & to come out from editing mode</p> <p> Clears the display(Resets to Zero)</p> <p> No Function</p>
				
				
				
				
				
				
				
				
				
				
				
				
				
				
				
				
				
			<p> Press To return to RUN mode lines</p>	

NOTE 1 : To change the values, the PR.LOC. Should be OFF in program mode
 NOTE 2 : To Display the value of SC, Direction should be set to DOWN in program mode
 NOTE 3 : To display the values of P1, P2, P3, P4 ... P16, PB corresponding preset assignments should be made in program mode

PROGRAM MODE:

LINE Number		FUNCTION	DESCRIPTION
MAX Count 6	MAX Count 6S		
3	4	START COUNT	Numeric Value for "set to a number". Conditional display: line direction must be 'Down'
N.A.	5	EARLY WARN PRESET	Numeric value for Early warn preset. Applied "above" and "below" other presets.
4	6	PRESET 1	Numeric value for Preset 1. May be turned 'ON' or 'OFF' with RST/CLR key before entering Edit mode.
5	7	PRESET 2	Numeric value for Preset 2. May be turned 'ON' or 'OFF' with RST/CLR key before entering Edit mode.
6	8	PRESET 3	
7	9	PRESET 4	
8	10	PRESET 5	
9	11	PRESET 6	
10	12	PRESET 7	
11	13	PRESET 8	
12	14	PRESET 9	
13	15	PRESET 10	
14	16	PRESET 11	
15	17	PRESET 12	
16	18	PRESET 13	
17	19	PRESET 14	
18	20	PRESET 15	
19	21	PRESET 16	Numeric value for Preset 16. May be turned 'ON' or 'OFF' with RST/CLR key before entering Edit mode.
20	22	BATCH PRESET	Numeric value for Batch Preset.
21	23	CORRECTION CONSTANT	Numeric constant that multiplies A & B.
22	24	INPUT MODE	Selects A-B, A+B x1 for open collector or contact inputs;
			Selects A-B, A+B x2 or Quadrature x2 or x4 for open collector inputs.
23	25	COUNT DIRECTION	Select UP for "reset to zero" or DOWN for "set to number"
24	26	DECIMAL POINT	Select decimal point position for Count, Total and Presets
25	27	FRONT PANEL RESET	Select ON or OFF.
26	28	COUNT RETENTION	Select ON or OFF (saves count during power down and programming).
27	29	PRESET LOCK	Select ON or OFF. Affect entry into SET UP mode.
28	30	TOTALIZER	Select ON or OFF
29	N.A.	STOP/HOLD SELECT	Select STOP count or Display HOLD function via external Input.
N.A.	31	STOP/HOLD/INCREMENT	Select STOP count, Display HOLD or INCREMENT preset functions
N.A.	32	OUT CONTROL/ DECREMENT	Select OUTPUT CONTROL or DECREMENT Preset via external input.
30	NA.	BATCH/ TOTAL RESET	Select BATCH or TOTALIZER Reset functions via external input.
NA.	33	BATCH/ TOTAL/ CYCLE RESET	Select BATCH, TOTALIZER, or CYCLE Reset functions via external input.

PROGRAM MODE

5. 0000000

E. 0000000 For MAX Count 6S only

1. 0000000

2. 0000000

3. 0000000

4. 0000000

5. 0000000

6. 0000000

7. 0000000

8. 0000000

9. 0000000

10. 0000000

11. 0000000

12. 0000000

13. 0000000

14. 0000000

15. 0000000

16. 0000000

P8. 0000000

CC. 10000

▶ To edit parameters
(The selected digit is highlighted)

▲ ▼ For Menu navigation

KEY Asks for a line counter LINE 00

▲ and ▼ Increment or Decrement the selected digit

▶ Pressing Right arrow key again - the highlighted digit moves from left to right one digit every time and it is cyclic.

KEY To save the value & to come out from editing mode

RST CLR Clears the display(Resets to Zero)

Presets 1 to 16 can be made ON and OFF by pressing RST / CLR key before entering edit mode

RST CLR Turns ON or OFF the presets

A-B CC.1 ▶ A-B OC.1 ▶ A+B CC.1 ▶ A+B OC.1 ▶

A-B OC.2 ▶ A+B OC.2 ▶ QUAD OC.2 ▶ QUAD OC.4

DIR. UP ▶ DIR. DN

DP. OFF ▶ DP. .0 ▶ DP. .00 ▶ DP. .000 ▶

DP. .0000

FPRST.OFF ▶ FPRST. ON

CORET.OFF ▶ CORET. ON

PRLOC.OFF ▶ PRLOC. ON

TOTAL.OFF ▶ TOTAL. ON

STOP. CC ▶ HOLD. CC ▶ INCPST. For MAX Count 6S only

OUT.CNTRL. ▶ DECPST. For MAX Count 6S only

BATCHRST. ▶ TOTALRST. ▶ CYCLERST. For MAX Count 6S only

Press

RUN PGM

To return to RUN mode lines

PROGRAM MODE:

LINE Number		FUNCTION	DESCRIPTION
MAX Count 6	MAX Count 6S		
31	34	OUTPUT 1	Select latched or pulsed operation for Output 1.
32	35	OUTPUT 2	Select latched or pulsed operation for Output 2.
33	36	OUTPUT 3	Select latched or pulsed operation for Output 3.
34	37	OUTPUT 4	Select latched or pulsed operation for Output 4.
35	38	OUTPUT 5	Select latched or pulsed operation for Output 5.
36	39	OUTPUT 6	Select latched or pulsed operation for Output 6.
37	40	PRESET 1 ASSIGNMENT	Assign output operations to Preset 1.
38	41	PRESET 2 ASSIGNMENT	Assign output operations to Preset 2.
39	42	PRESET 3 ASSIGNMENT	
40	43	PRESET 4 ASSIGNMENT	
41	44	PRESET 5 ASSIGNMENT	
42	45	PRESET 6 ASSIGNMENT	
43	46	PRESET 7 ASSIGNMENT	
44	47	PRESET 8 ASSIGNMENT	
45	48	PRESET 9 ASSIGNMENT	
46	49	PRESET 10 ASSIGNMENT	
47	50	PRESET 11 ASSIGNMENT	
48	51	PRESET 12 ASSIGNMENT	
49	52	PRESET 13 ASSIGNMENT	
50	53	PRESET 14 ASSIGNMENT	
51	54	PRESET 15 ASSIGNMENT	
52	55	PRESET 16 ASSIGNMENT	Assign output operations to Preset 16.
53	56	RESET INPUT ASSIGNMENT	Assign output operations to Reset input.
54	57	OUTPUT CONTROL ASSIGNMENT	Assign output operations to Output Control Input.
55	58	BAUD RATE	Selects OFF, 1200, 2400, 4800 or 9600 baud.
56	59	ID NUMBER	Serial ID Number. Programs unit serial address.

PROGRAM MODE

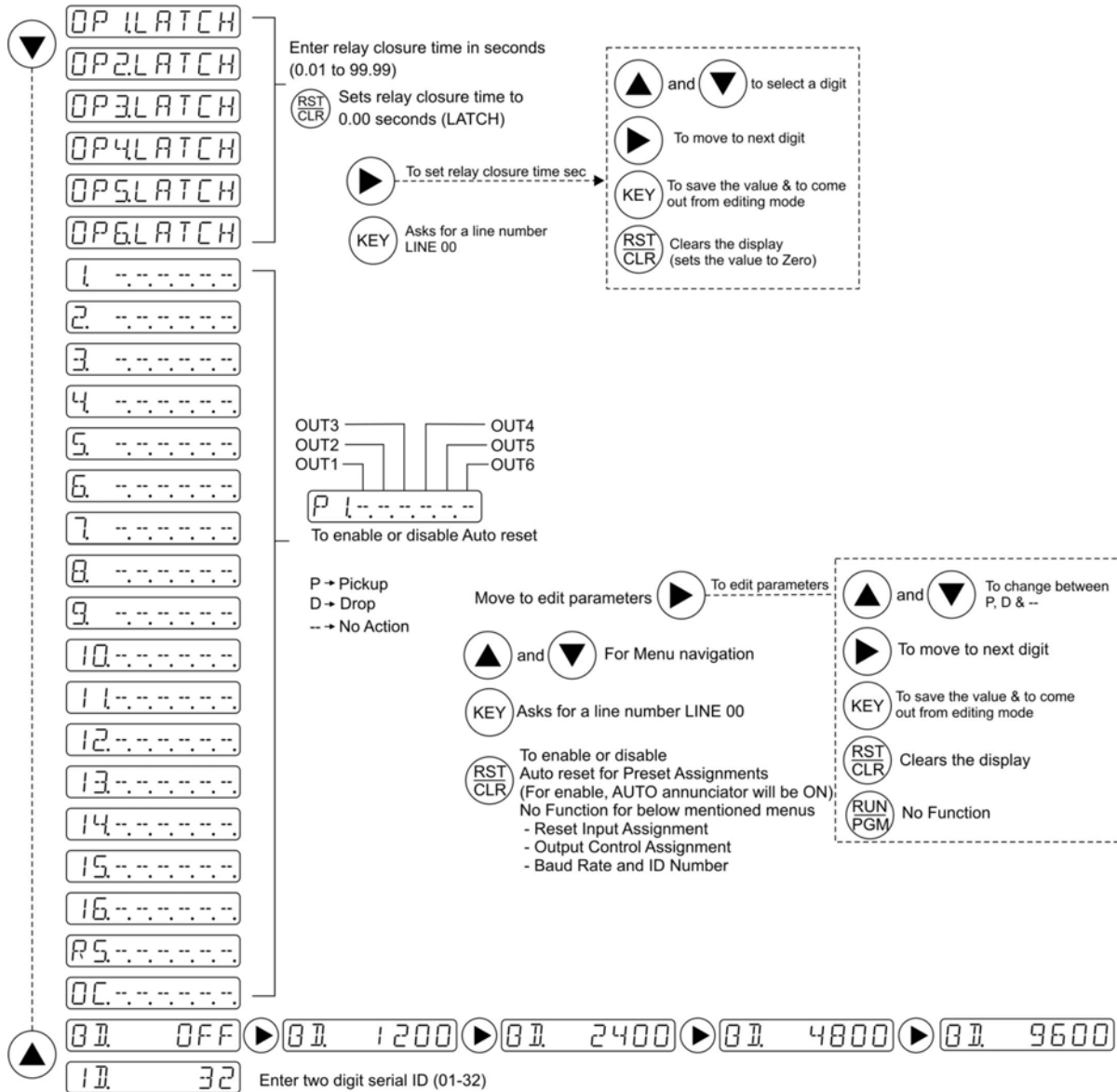

The **MAX** Count 6 & 6S Advanced controller provides a group of diagnostics to self test the controller and field wiring as well as helps the user diagnose machinery malfunctions. Eight diagnostic tests are provided and can be run only while the unit is in the PROGRAM mode. These tests should be done “offline” (user’s process not being controlled). The tests are outlined below along with the keyboard commands to control them.

LINE Number		FUNCTION	DESCRIPTION
MAX Count 6	MAX Count 6S		
57	60	TEST 0	Keyboard Test: Display echoes on each key press.
58	61	TEST 1	FRAM Memory Test.
59	62	TEST 2	Input Tests: Test for “Closures” on Inputs.
60	63	TEST 3	Output Test: Press ► key to select the outputs using ▲ and ▼, press ► Key to turn ON. Press CLR to Turn ‘OFF’.
61	64	TEST 4	Display Test: Illuminates all segments.
62	65	TEST 5	Version code Test: Displays date code version of firmware.
63	66	TEST 6	Serial Test: Provides loop-back test of the serial transmitter and receiver (will indicate ‘FAIL’ if the loop back connectors are not made).
64	67	TEST 7	Returns controller to the factory programmed state.

Test T0: Display shows: **T0. RDY**
 Press RIGHT key
 Then it will display **T0 RUN**
 The display with corresponding key press will be as shown below:

Key	Display
▲	UP KEY
▼	DOWN KEY
►	RIGHT KEY
KEY	Exits from the menu shows T0 RDY
RST/CLR	RESET KEY
RUN/PGM	RUN KEY

Test T1: Display shows: **T1. RDY**
 Press RIGHT key
 Then it will display **PASS/FAIL** indicating the FRAM test. Pass will be displayed if FRAM is ok. If Fail displayed means there is a problem with FRAM call Eagle Signal.
 Press **KEY** key to exit from the menu and the display show **T1. RDY**

Test T2: Display shows: **T2. RDY**
 Press RIGHT key
 Then it will display **IN** and the inputs connected to it (A and B) and it will display the following for the control inputs when externally pulled low.

Control input	Display
STOP/HOLD/ <i>*INCREMENT</i>	1
OUTPUT CONTROL	2
COUNTER RESET	3
BATCH/TOTAL/ <i>*CYCLE RESET</i>	4

<i>* Applies for MAX Count 6S</i>

Press **KEY** key to exit from the menu and the display show **T2. RDY**

- Test T3:** Display shows: **T3. RDY**
Press RIGHT key
Then the display shows **OUTTST 1** and by scrolling up and down **OUTTST 2 to OUTTST 6** are displayed, press **RIGHT** key the corresponding Solid State / Relay output ON.
Press **RST/CLR** to make Solid State / Relays output OFF.
Press **KEY** key to exit from the menu and the display show **T3. RDY**
- Test T4:** Display shows: **T4. RDY**
Press RIGHT key
Then all the LED's and annunciators glows indicating that the test is passed.
Press **KEY** key to exit from the menu and the display show **T4. RDY**
- Test T5:** Display shows: **T5. RDY**
Press RIGHT key
It displays the version of the current module. (**VER 1**)
Press **KEY** key to exit from the menu and the display show **T5. RDY**
- Test T6:** Display shows: **T6. RDY**
Press RIGHT key
Shows FAIL/PASS indicating Serial communication is OK (if RXD+ shorted to TXD+ and RXD- shorted to TXD-) or not.
Displays **PASS** if serial communication is OK
Displays **FAIL** if serial communication is not OK.
Press **KEY** key to exit from the menu and the display show **T6. RDY**
- Test T7:** Display shows: **T7. RDY**
Press RIGHT key
Display shows **T7 RUN**. It loads all the factory programmed values.
Press **KEY** key to exit from the menu and the display show **T7. RDY**

EDITING PARAMETERS:

Enter the program mode by following the Note mentioned below. Reach a particular line which is required to change by pressing DOWN key then press RIGHT Key, the first digit Highlights, which indicate edit mode. Edit value by using UP and DOWN keys, then press RIGHT key which will highlight the next digit. After entering the value, to confirm or exit from edit mode, press **KEY** key.

NOTE 1:

To enter program mode from run mode, Press RUN/PGM key, Then the display shows **LOC 0000**, with the first digit highlighted. Then edit the value by using UP and DOWN key for the first digit as **2**, then press RIGHT key which will take the highlighting to second digit. Enter value as **6**, similarly enter 3rd and 4th digits as **6**. After entering the value for **LOC as 2666**, Press **KEY** key, it will enter to program mode.
If the LOC doesn't match with 2666 then it will return to RUN Mode.

RUN MODE OPERATION: (For Max count 6 only)

The controller will process the presets in an absolute manner. That is to say that all the presets are active unless the user turns the preset(s) 'OFF'. Presets may be entered in any order; they need not be in ascending order. Output action that is associated with each preset is user programmable for presets 1 through 16. The Batch preset is pre-assigned to Batch output and is defined as a 150ms momentary output.

If the unit is programmed for "Reset to Zero" (Count 'Up' on line 23), the counter will reset to zero when the Reset input is activated. The counter may count UP or DOWN from this point dependent only on the signals applied to the SIG A and SIG B inputs. If the unit is programmed for "Set to a Number" (Count 'Dn' on line 23), operation the unit will preset to the start count value when the Reset input is activated. From this point the counter may count UP or DOWN dependent only on the signals applied to the SIG A and SIG B inputs.

RUN MODE OPERATION: (For Max count 6S only)

The controller will process the presets in ascending sequential order (P1, P2, P3, —P16) without regard to the absolute value of the preset. Individual preset may be enabled or disabled by the user. Presets that are turned OFF are skipped by the preset processing logic. Display line 4 shows the currently active preset. Output action that is associated with each preset is user programmable for presets 1 through 16. The Early Warn preset has a pre-assigned output and fixed 150ms momentary time. The batch preset has a preassigned output and a fixed 150ms. momentary time.

If the unit is programmed for "Reset to Zero" (Count 'Up' on line 25), the counter will reset to zero when the Reset input is activated. The counter may count UP or DOWN from this point dependent only on the signals applied to the SIG A and SIG B inputs. If the unit is programmed for "Set to a Number" (Count 'Dn' on line 25) the unit will preset to the start count value when the Reset input is activated. From this point the counter may count UP or DOWN dependent only on the signals applied to the SIG A and SIG B inputs.

SETUP MODE OPERATION:

The SETUP mode allows the user to edit the Main Counter presets, the Batch Counter Preset, and the Start Count Value. The Preset Lock must be 'OFF' to enter the SETUP mode. Press the KEY button to enter the SETUP mode. When the user enters SETUP mode the 'SET' annunciator is lit indicating the SETUP mode operation.

The controller continues to function normally (Comparing presets and producing outputs) while in the SETUP mode. Data entry for the SETUP mode is the same as for the PROGRAM mode. Changes to the operational presets are made upon exiting the SETUP mode. Any changes made in the SETUP mode are permanently saved at the appropriate program line when the SETUP mode is exited. Exit the SETUP mode by pressing the KEY button. The 'RUN' annunciator is lit upon exiting the SETUP mode.

CAUTION

The user should use great caution when editing presets in the setup mode. Preset comparisons will be made with the edited presets upon exiting the SETUP mode and entering the RUN mode. Preset comparisons are made follows: When the preset changes from $>$ the count value to \leq the count value or when the preset changes from $<$ the count value to \geq the count value. External machine logic circuitry should be designed to handle this. If a change must be made, make it when the counter value is;

- A). Less than both the "old" and "new" preset value for the count up operation, or
- B). Greater than both the "old" and "new" preset values for count down operation.

PROGRAM MODE OPERATION:

The PROGRAM mode allows the user to configure the controller for his particular application. The PROGRAM mode can be entered at any time while in the RUN mode of operation. It cannot be entered from the SETUP mode. The PROGRAM mode is entered by pressing RUN/PGM keyboard key and then entering the Lock code (2-6-6-6) and pressing KEY key. The display will remain on the LOC Prompt line until the KEY-key press. If a valid lock sequence is not entered the controller will return back into the RUN mode and when the user enters the PROGRAM mode the PGM annunciator will lit indicating PROGRAM mode operation.

Outputs are dropped out and counting is inhibited when entering the PROGRAM mode. Refer to the section on Count Retention for optional non-volatile count and output status while in the PROGRAM mode and when exiting the PROGRAM mode.

The user should perform all his basic control setup while in the program mode. This includes: correction constant, Input mode, Count Direction, Output Operation etc. Preset programming should also be done in the PROGRAM mode since it affords the best protection from unauthorized changes.

Since the PROGRAM mode includes the diagnostics tests it is important that the controller be "off line" (user's process not being controlled) while the PROGRAM mode is entered if the diagnostics are to be run.

The PROGRAM mode is exited by pressing the RUN/PGM key. The 'PGM' annunciator will go out and 'RUN' annunciator will be lit indicating RUN mode operation.

COUNT RETENTION

The user may program the Count Retention feature to be 'ON' or 'OFF'. When count retention is turned 'OFF', the main counter is held reset and the outputs are de-energized when entering and exiting the PROGRAM mode and when the controller is powered up and down. When count retention is turned 'ON', the count value in the main counter is saved, counting is inhibited and the outputs are de-energized when entering the program mode and when the controller is powered up and down. The count retention feature does not directly affect the totalizing counter or the batching counter since these counters are always saved under all conditions.

WARNING

When returning to the RUN mode the count value that was previously saved will cause output actions to occur (outputs will trigger momentarily or latch) as dictated by the comparison of the counter and the presets. This action also occurs at the power up. External machine logic must be designed to handle this!

INPUT MODE PROGRAMMING

The input mode is provided to select all legal combinations of input logic, input mode and sensor type. This allows the user to effectively increase the resolution of the count input transducer.

You can not select input x2 or x4 logic for the contact closure inputs. You cannot select x4 logic for unidirectional solid state inputs. x2 logic detects leading & trailing edges of each input signal, x4 logic detects leading & trailing edges of both input signals for quadrature input only.

CORRECTION CONSTANT:

The Correction constant has a range of five decades and is user programmable. This feature allows the user to factor the incoming count into useful engineering units (inches, cm, mm, etc.). The resolution of the count transducer and input logic should be chosen to take advantage of the best instantaneous accuracy of the calibrator. The best instantaneous accuracy is obtained with a correction constant setting not exceeding 1.0000. The general form of the equation for the correction constant is given below.

$$CC = \frac{\text{Displayed Value in Engineering units}}{(\text{Display Resolution}) \times \text{Input pulses} \times \text{Input logic}}$$

(Where input Logics is x1, x2 or x4)

BATCH COUNT OPERATION: (For Max count 6 only)

The Batch Counter is incremented each time an Auto Reset assignment is processed by the Controller. The Batch Counter is compared to the Batch Preset and a momentary output is generated on the Batch output when the Counter \geq Preset. The Batch Counter is automatically reset when the output is generated. The Batch output may be disabled by turning the Batch Preset 'OFF'. The Batch Counter free-runs without resetting when the Batch Preset is turned 'OFF'. The Batch counter may be reset via the front panel by scrolling to the Batch Counter line then pressing RST/CLR key. It may also be reset externally if the BATCH/TOTAL reset input is selected as 'Batch Reset' on line 30 of the programming table.

CYCLE BATCH COUNTER OPERATION: (For Max count 6S only)

The cycle batch counter is incremented when the last preset (complete cycle) is processed by the controller. The cycle batch counter is compared to the cycle batch preset and a momentary output is generated on the batch output when the counter \geq preset. The batch counter is automatically reset when the output is generated. The Batch output may be disabled by turning the cycle batch counter preset 'OFF'. The batch counter runs without resetting, when the batch preset is turned 'OFF'. The batch counter may be reset via the front panel by scrolling to the batch counter line then pressing the RST/ CLR key. It may also be reset externally if the BCH/ TOT/ CYCL reset input is selected as batch reset on line 33 of the program table.

TOTALIZER OPERATION

The Totalizer counts in parallel with the main counter when selected 'ON' in the program table. The totalizer may be reset via the front panel by scrolling to the Totalizer line then pressing the RST/CLR key. It may also be reset externally if the BCH/ TOT/ CYCL reset input is selected as total reset of the program table.

RESET INPUT:

The reset input is used to reset the main counter and to manually start control cycles from an external input. If the controller is programmed for 'Reset to zero' (Count 'UP'), the controller will reset the main counter to zero when the reset input is activated. If the controller is programmed to 'Set to Number' (Count 'DN'), the controller will preset the main counter to the start count value when the main RESET is activated.

STOP/HOLD/ INC-PRESET INPUT:

The STP/ HLD/ *INC input is programmable as either a STOP count, display HOLD or as a INCREMENT preset input function as selected from of the program table. When selected as a STOP count input function a contact closure causes the input counts to the main counter and totalizing counter to be inhibited (Counter will not count) as long as the contact is closed. When selected as display HOLD function a contact closure causes the front panel display to be "Frozen" but lets the controller continue to count as long as contact is closed. The display hold does not affect the data being transmitted via the serial interface. [*When selected as an INCREMENT preset function a momentary contact closure on this input causes the controller to 'INCREMENT' to the next preset thus effectively skipping the current preset. For example if P4 was being processed and an increment input is given the active preset will be increment to P5. If two INCREMENT inputs were given the active preset would be P6 & so on. In this manner the user may selectively skip presets from an external control device.*]

OUT.CNTRL / DEC-PRESET INPUT: (For Max count 6S only)

The OUT.CNTRL / DEC.PST input is programmable as either OUTPUT CONTROL or DECREMENT preset control input as selected on line 32 of the program table. When selected as OUTPUT CONTROL input a momentary contact closure causes the controller to perform those output actions. Outputs may pickup, dropout or perform no output action as selected by the user. When selected as DECREMENT preset function a momentary contact closure on this input causes the controller "decrement" to the prior preset thus effectively repeating that preset. For example if P6 was being processed and a decrement input is given the active preset will be decrement to P5. If two DECREMENT inputs were given the active preset would be P4 & so on. In this manner the user may repeat presets from an external control device.

MAX Count 6 Applications:

ROLL FORMING

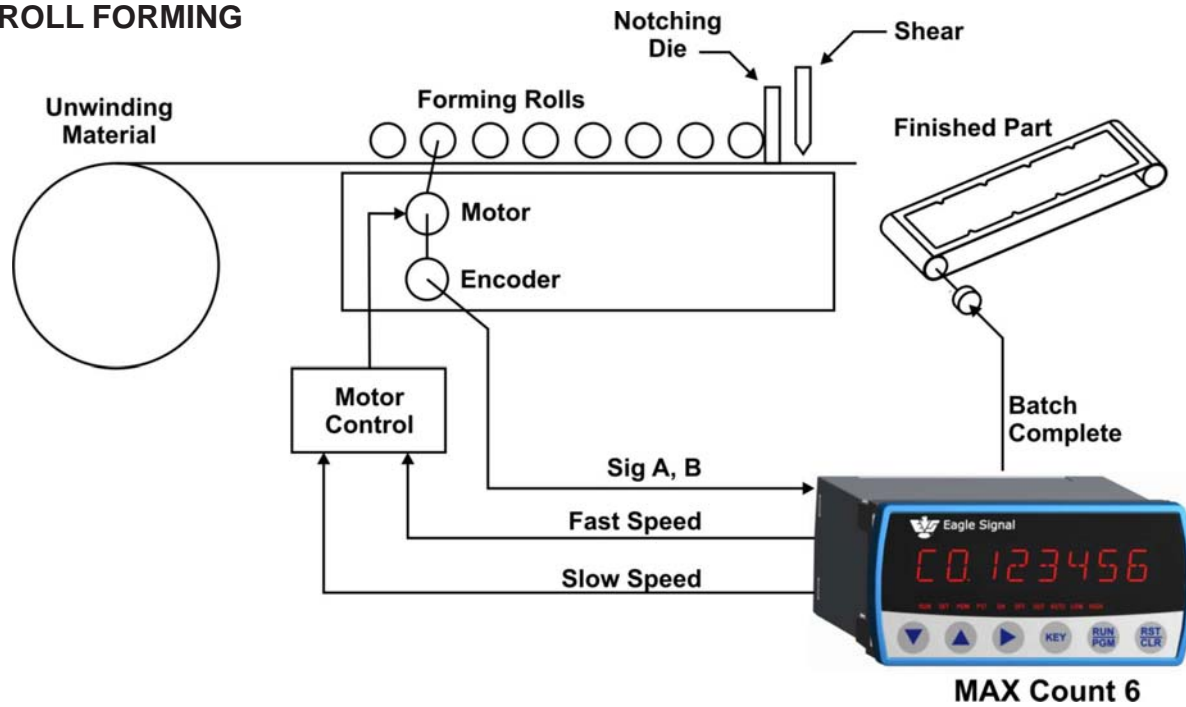

MACHINE TOOL POSITION CONTROL

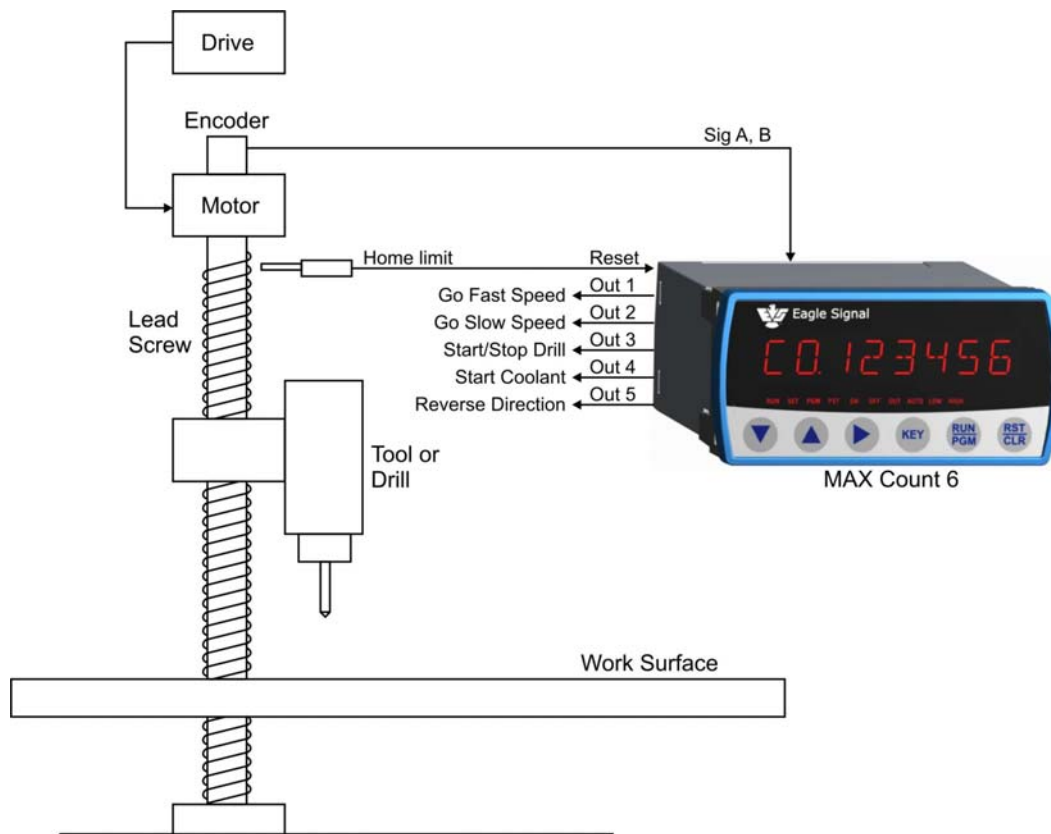

HEAT TREATING

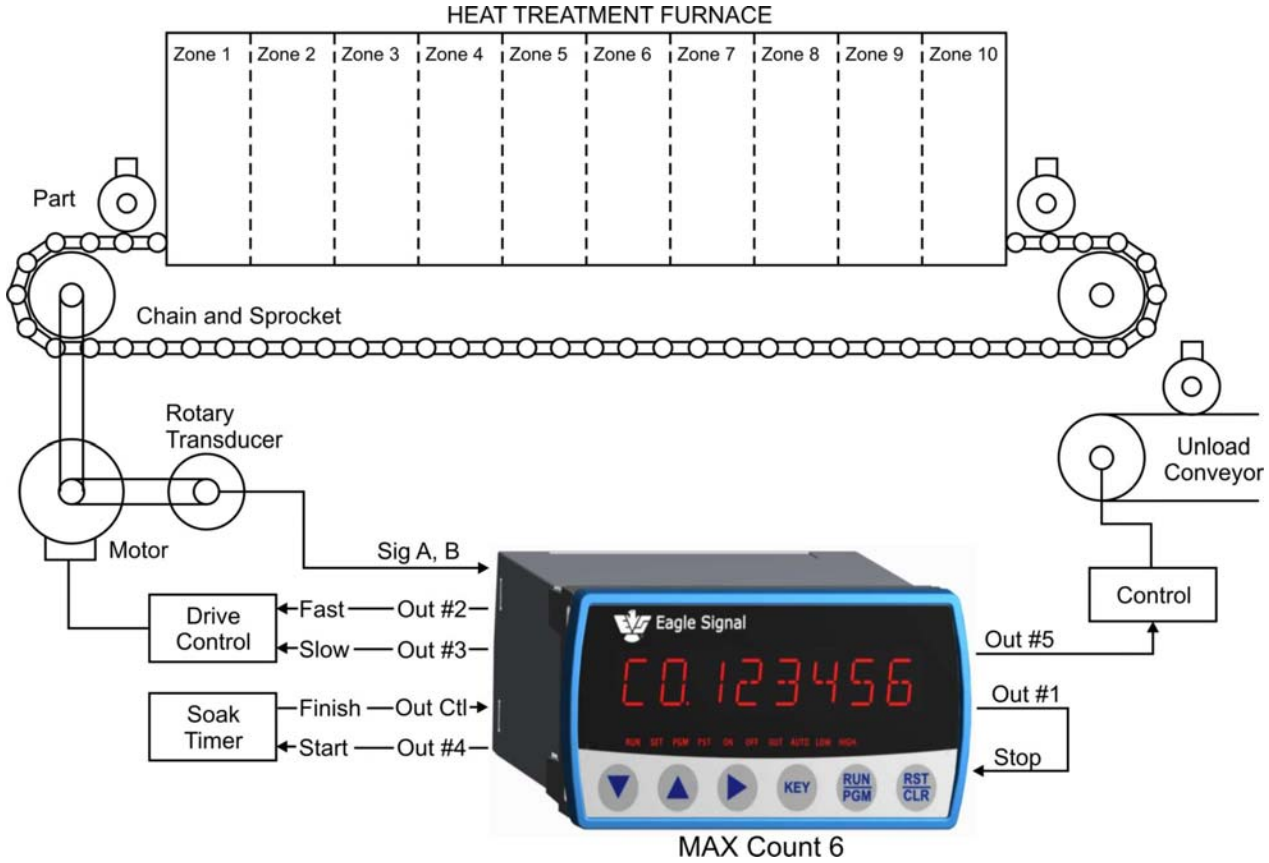

MAX Count 6S Applications:

SHEET METAL FABRICATION PUNCH and SHEAR

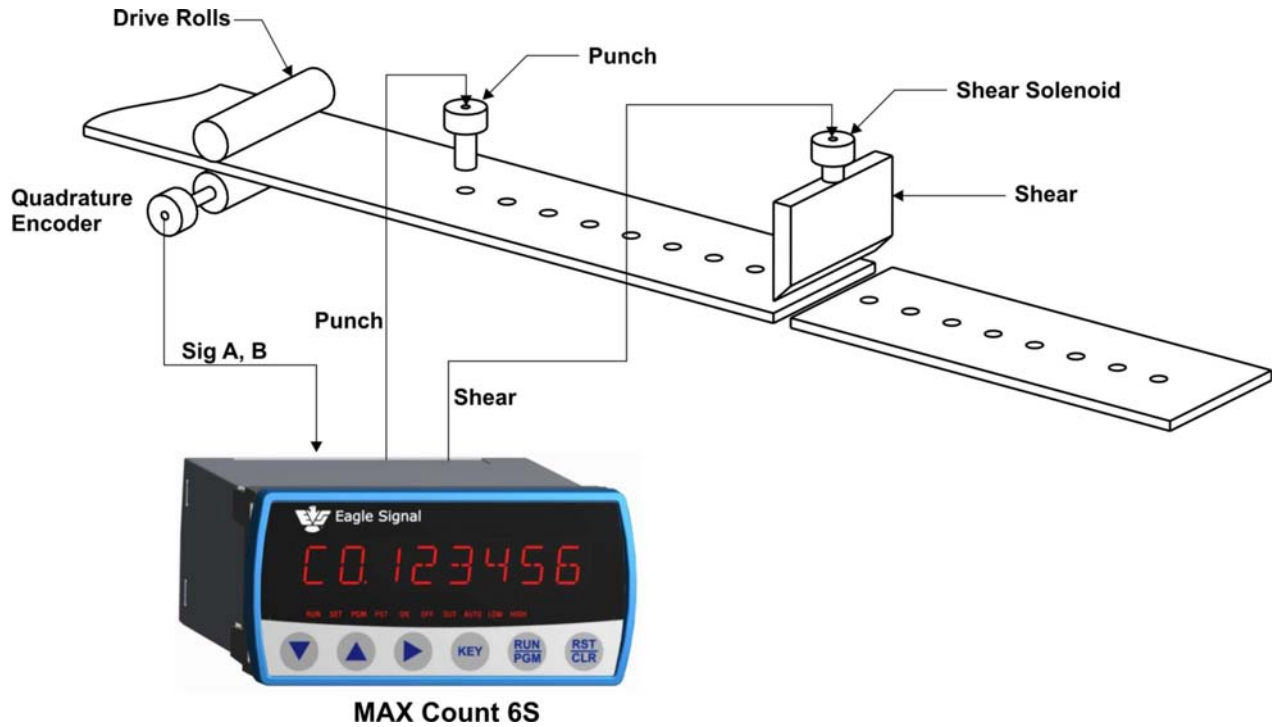

COIL WINDING

Applications include : Motor Starters,
Transformers, Inductors, Ballast, etc.

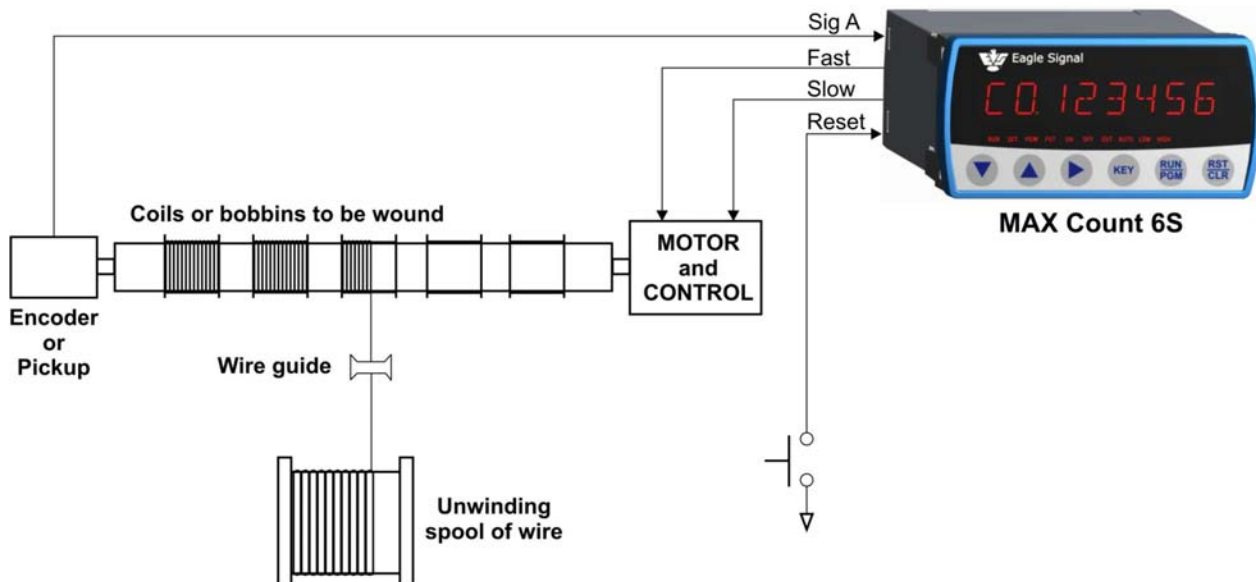

SHEET METAL FABRICATION PUNCH, WELD and SHEAR

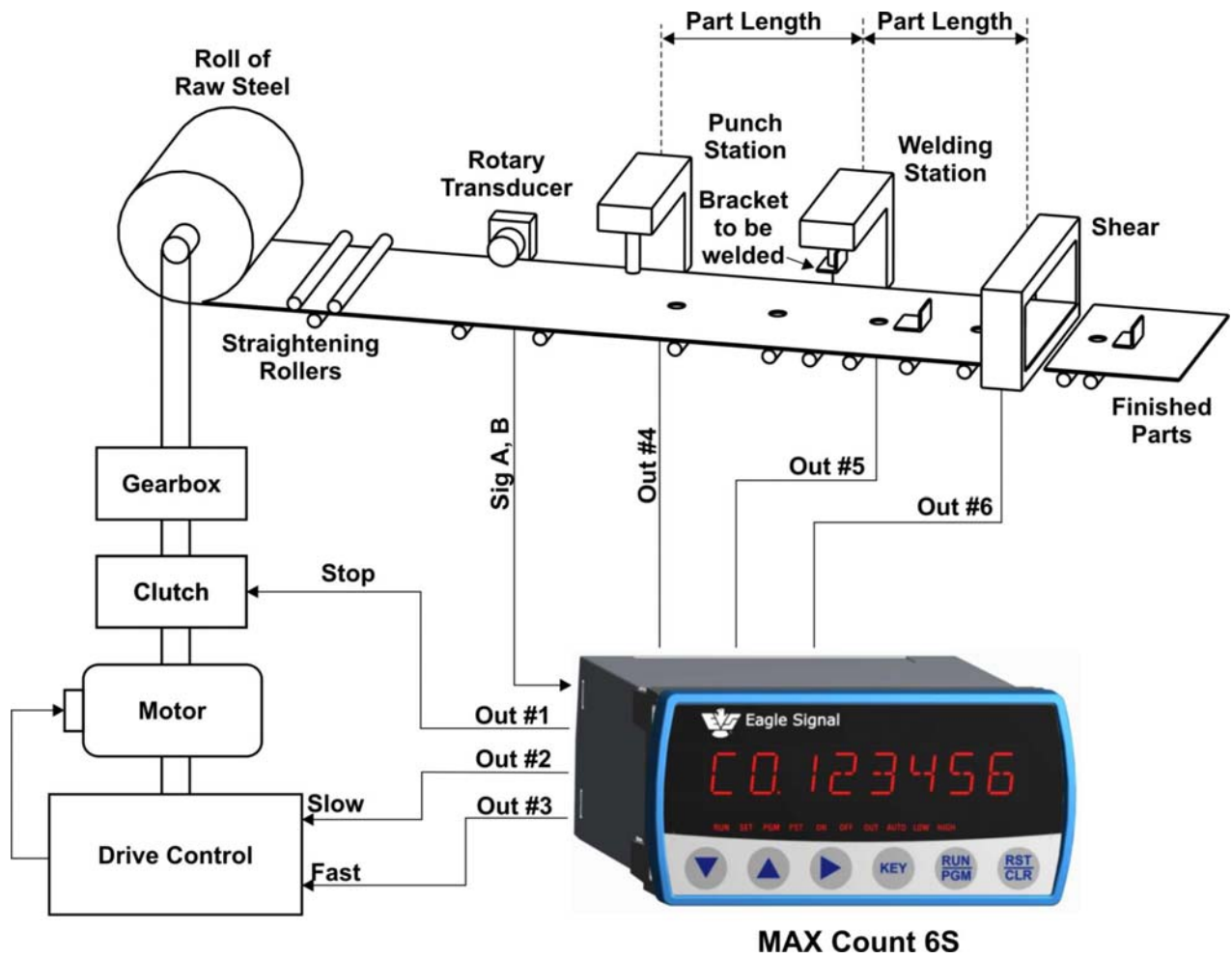

NOTES:

1. Installations must be made in accordance with manual 845 - 130.
2. For application which require multiple products operation in parallel, see 845 - 130.
3. When replacing older products, consult 845 - 130 for information regarding circuitry changes.

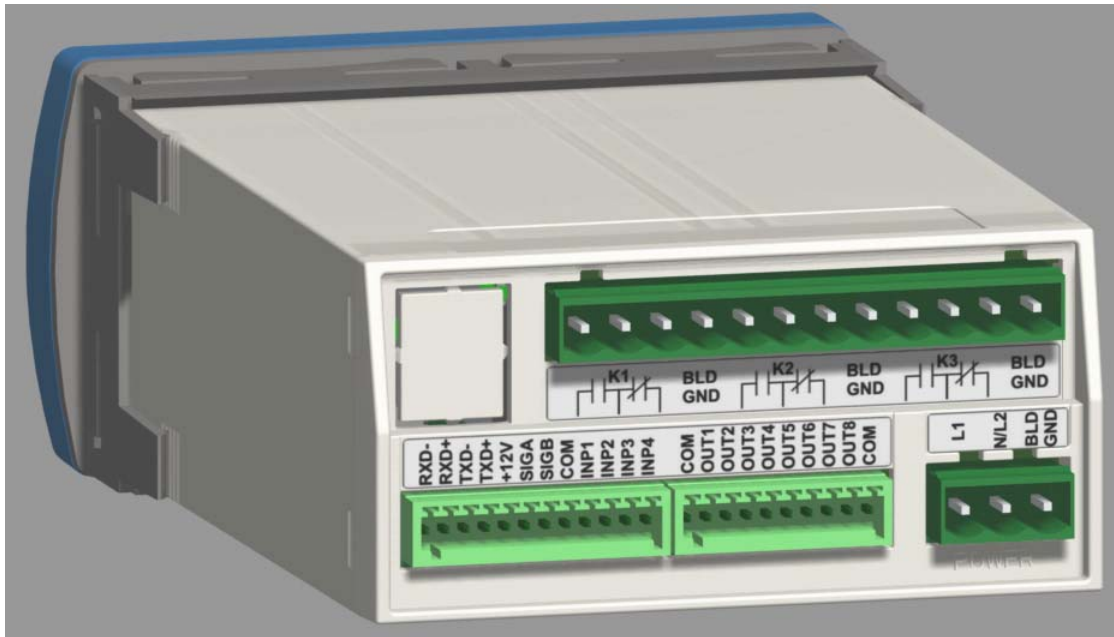

A. PANEL MOUNTING:

Make Panel Cutout. Affix adhesive gasket (if required) to panel. Remove the Unit holder and slide unit through the cutout. Slide back the Unit holder.

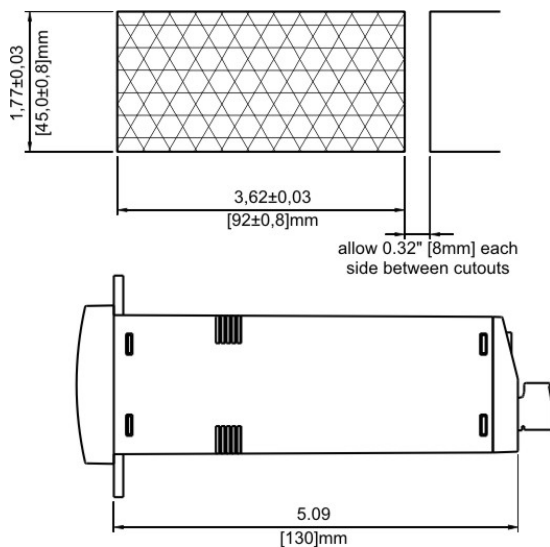

B. INPUT POWER

AC POWER

Connect AC power to the unit Connect terminal **BLD GND** to BUILDING GROUND!

UNIT REQUIRES EXTERNAL FUSE. USE 1/4A. FOR 115V (1/8A FOR 230V) FAST-BLOW

85-265 VAC, 50 / 60Hz, 20 VA

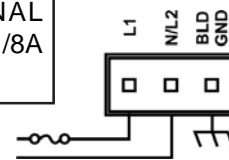

DC POWER

Connect +12 VDC to terminal **L1** and 12 Volt ground to terminal **N/L2**. Connect terminal **BLD GND** to BUILDING GROUND!

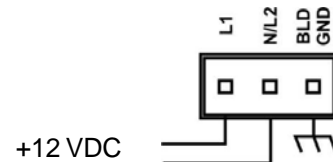

C. CONTROL INPUTS

STOP/HOLD/*INCREMENT PRESET (Term INP1)

Level sensitive 25 Hz Response 4.7 kΩ to + 12 VDC (Shows '1' during input diagnostic test).

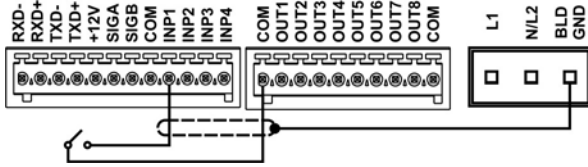

OUTPUT CONTROL/*DECREMENT PRESET (Term INP2)

Edge sensitive 25 Hz Response 4.7 kΩ to + 12 VDC (Shows '2' during input diagnostic test).

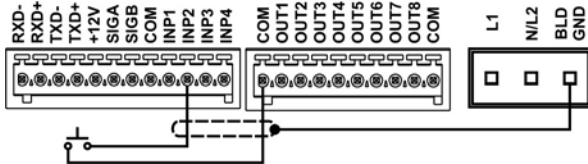

COUNTER RESET (Term INP3)

Edge sensitive 25 Hz Response 4.7 kΩ to + 12 VDC (Shows '3' during input diagnostic test).

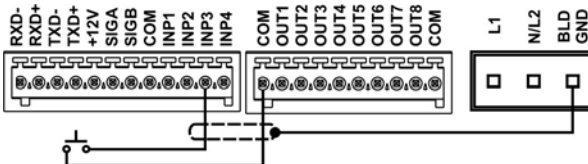

BATCH/TOTAL/*CYCLE RESET (Term INP4)

Edge Sensitive 25 Hz Response 4.7 kΩ to + 12 VDC (Shows '4' during input diagnostic test).

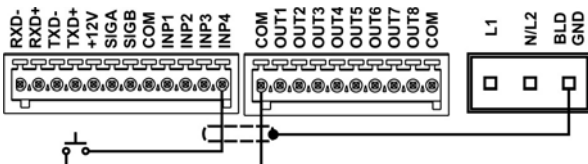

D. CONTROL OUTPUTS

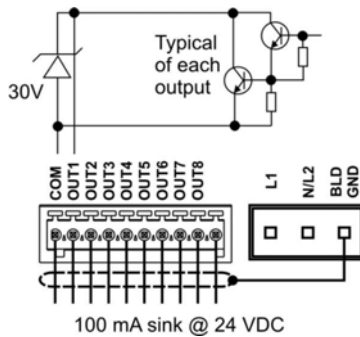

GENERAL WIRING RULES:

1. Use only Shielded cables for all signal wiring.
2. Separate signal and load switching wiring.
3. Supply AC power through a separately fused circuit
4. Terminal connector plug accepts 20 - 28AWG wires

E. COUNTER INPUTS

BIDIRECTIONAL ENCODERS

(Type 42, 62 Rotopulser)

SIG A leads SIG B by 90 deg 1.0 kΩ to COM

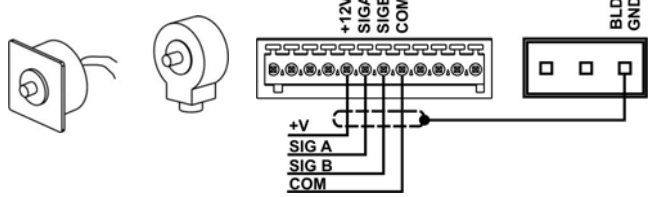

UNIDIRECTIONAL ENCODERS

(Type 53 Pickup, 76 Roto)

SIG A Adds; SIG B Subtracts 1.0 kΩ to COM

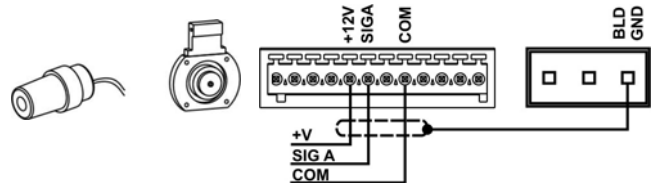

OPEN COLLECTOR (NPN)

SIG A Adds; SIG B Subtracts 1.0 kΩ To COM

Customer supplied Pullup Resistor (typ)

2.2 kΩ max. to +12V; 470 Ω max to +5V

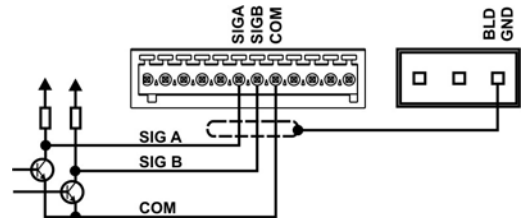

OPEN COLLECTOR (PNP)

(PNP)

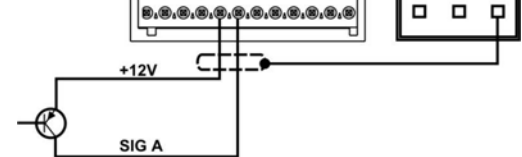

CONTACT CLOSURE / SWITCH

SIG A Adds; SIG B Subtracts 1.0 kΩ To COM

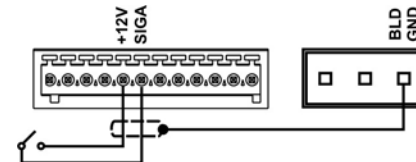

F. RELAY OUTPUTS

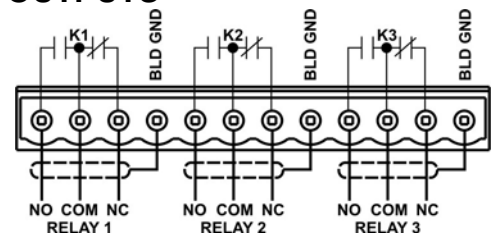

Replacement Arrangement: (To Mount MAX Count 6 & 6S Advanced in 1/4 DIN panel cutout)

Follow these steps to mount **MAX** Count 6 & 6S Advanced in place of existing Max Sr. Products, Panel cutout Size of 5.43" x 2.68".

- a) Affix adhesive gasket (if required) to panel.
- b) Insert Large Bezel from front size.
- c) Match the locking plates to the mounting holes of the bezel from inside and drive the screws.
- d) Remove the Unit holder of the **MAX** Count 6 & 6S Advanced and slide unit through Large Bezel from front and slide back the unit holder.

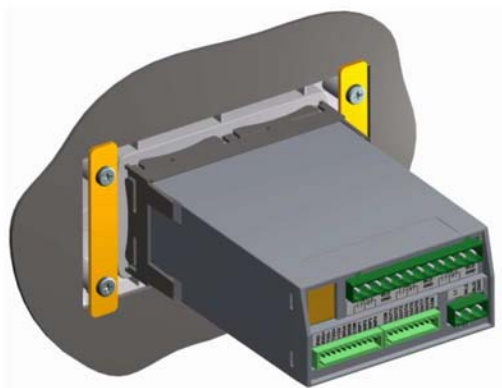
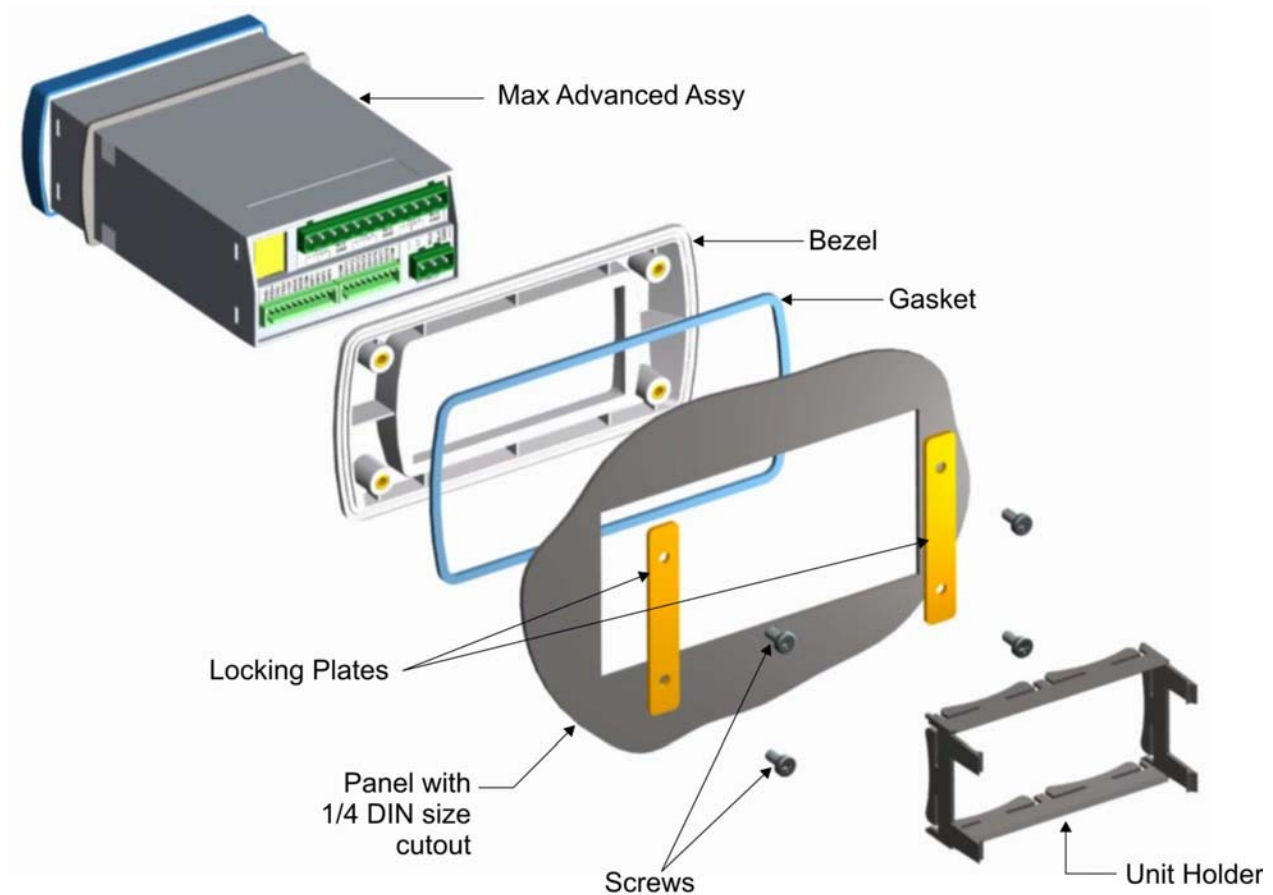

Rear View



Front View

OVERVIEW

The **MAX** Count 6 & 6S Advanced are equipped with an RS-485 Serial interface for remote data collection, programming and networking applications. Front panel keyboard and some external control inputs are supported. Additionally, facilities are provided for individual (local) and group (global) control of single and multiple unit configurations respectively in a bus oriented system. Knowledge of serial communications is required by the user who wishes to use the remote capabilities or to integrate the control into a larger system.

Two applications will be discussed. The first consists of a single **MAX** Count 6 & 6S Advanced and a display terminal. It explains the use of the serial commands that mimic the keyboard operation and some control inputs. These are the LOCAL commands. Next, an application of multiple units under the control of a host computer will be discussed. The GLOBAL commands will be discussed in this section.

SERIAL CONNECTIONS

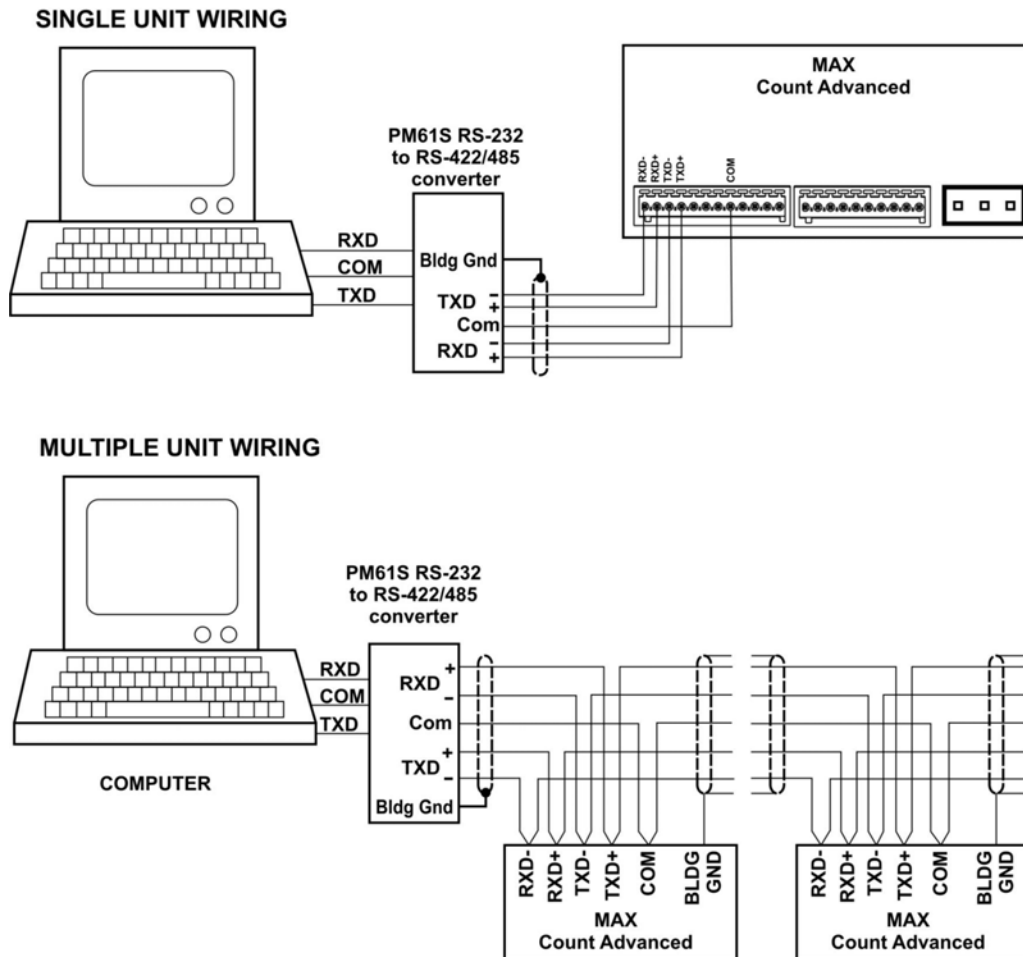

TERMINATION

The RS-485 receivers require the termination to minimize the effects of noise while the bus is not being driven. The **MAX** and PM61 products incorporate the terminations shown on the right internally. When connection is made to RS-485 device other than a **MAX** or PM61, the receiver should be terminated as shown.

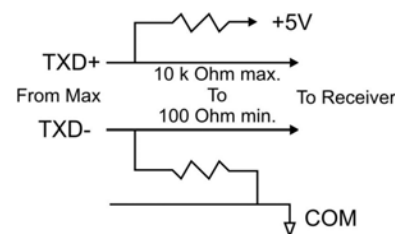

CABLE SELECTION

The **MAX** serial interface uses a simple interconnect scheme and low cost wiring making it superior to parallel data transfer schemes. Through three (3) wire pairs, remote operation at distances up to 5,000 feet can be implemented. The following general guidelines should be observed.

1. Use #24 AWG twisted pair, overall shielded cable.
2. Use a "daisy chained" connection scheme for bus systems.

3. If a "multidrop" system is used, keep the drop length at 10% of the main line.
4. Tie the cable shield to BUILDING GROUD at the MAX end of the cable.
5. Crimp both the wires to a common lug for Multiple unit wiring.

RECOMMENDED CABLE TYPES:

Belden #9503
Alpha #5493

PROTOCOL : Modbus RTU

Modbus is the one of the industrial standard protocol. There are two types of Modbus implementation, one is 'ASCII' and other is 'RTU', since RTU (Remote Terminal Unit) is the more popular, **MAX** Count 6 & 6S Advanced has supported 'Modbus RTU' Protocol.

Modbus RTU protocol is supported by almost all industrial standard automation products like PLCs , Motor Drives, DCS, and SCADA etc.

Modbus is a Message based master-slave type protocol, where as there is a one master on a multi-drop communication bus and several slaves connected which are addressed as per their unique slave id. The master sends a query to slaves to read the data from slave as well as writes data on the slave.

Following is the serial port specifications:-

Baud Rate:- Programmable as OFF (OFF= no communication) or 1200, 2400, 4800, 9600

Data format:- 8 bit , no parity, 1 start bit, 1 stop bit

Supported Modbus Queries: **MAX** Count 6 & 6S Advanced supports the three types of modbus commands,

1. Command 03 (Read Holding Register)
2. Command 16 (WRITE Holding Registers)
3. Command 04 (Read Input Register)

Description of modbus commands:-

Command 03 (Read Holding Register)

Read Multiple Holding Registers.

This command will allow the master to read Programmed Parameters like presets settings etc. Using this command maximum 2 numbers of 16 bit integers can be read together in single query. That means, 3 or more holding register read can not be done in a single query. Multiple queries can be sent for different address to read

the data from instrument. Since most of the variables are 32 bit long integers, the modbus master need to read two concurrent integer words and combine them to form a 32 bit long integer for processing.

Following is an example of how to do it.

Assume that the value of the Start Counts SC is 123456. The Hex value will be 1E240H. The Holding Register address of SC is (40000 : 40001) and hence, address 40000 will contain 01h (Most Significant word) and address 40001 will contain E240h value (Least significant word).

Note:

Ensure to switch OFF & ON the unit after editing the programming parameters through the MODBUS commands.

- | |
|--|
| <ol style="list-style-type: none">1. PLC: Programmable Logic controller,2. DCS Distributed Control Systems3. SCADA: Supervisory controls and Data Acquisition. |
|--|

Command 03...

Format of command as per above example where SC is having 123456 value
 Following will be a query from master followed by the response from the slave.

Byte No	Hex Value	Description	Remarks
1	01	Slave ID	Should be matching with Slave ID set on the instrument
2	03	Command to read holding reg.	Address of the register to read 0000= SC Hi, 0001 = SC Lo etc
3	00	Starting Address Hi byte	
4	00	Starting Address Lo byte	
5	00	Number of Registers Hi byte	Number of registers to read in single command. Can not be greater than 0002 for MAX products.
6	02	Number of Registers Lo byte	
7	CRC Lo	CRC Lo byte	16 bit CRC, Data validation code
8	CRC Hi	CRC Hi byte	

Following will be the Response from the instrument. Multiple slave units may be connected to Modbus RS485 bus, the instrument with Slave ID=1 will respond to this query.

Byte No	Hex Value	Description	Remarks
1	01	Slave ID	Should be matching with Slave ID set on the instrument
2	03	Command to read holding reg.	
3	04	Number of bytes of data being sent	
4	00	Hi byte of requested register (40000 in this case)	
5	01	Lo byte of requested register (40000 in this case)	Data of the requested register
6	E2	Hi byte of requested register (40001 in this case)	
7	40	Lo byte of requested register (40001 in this case)	
8	CRC Lo	CRC Lo byte	16 bit CRC, Data validation code
9	CRC Hi	CRC Hi byte	

Command 16: (WRITE Holding Registers)

This Command is used to write/Edit programmable Parameters. Following example illustrates how to write P1 the values 345678 .

P1 setting value 345678 = 5464E hex.

Following is the Query through which SC and P1 values will be edited

Byte No	Hex Value	Description	Remarks
1	01	Slave ID	Should be matching with Slave ID set on the instrument
2	16	Command to Write holding register	
3	00	Hi byte of requested register (40000 in this case)	For 2 number of registers, 4 bytes of data . will be sent
4	00	Lo byte of requested register (40000 in this case)	
5	00	Hi byte of requested number of registers.	Number of registers to update (Max 2)
6	02	Lo byte of requested number of registers.	
7	00	Hi byte of Data integer	Data for register 40000
8	05	Lo byte of Data integer	
9	46	Hi byte of Data integer	Data for register 40001
10	4E	Lo byte of Data integer	
11	CRC Lo	CRC Lo byte	16 bit CRC, Data validation code
12	CRC Hi	CRC Hi byte	

Following will be the Response from the instrument. Multiple slave units may be connected to Modbus RS485 bus, the instrument with Slave ID=1 will respond to this query as follows.

Byte No	Hex Value	Description	Remarks
1	01	Slave ID	Should be matching with Slave ID set on the instrument
2	16	Command to Write holding reg.	
3	00	Hi byte of requested register (40000 in this case)	
4	00	Lo byte of requested register (40000 in this case)	
5	00	Hi byte of requested number of registers.	
6	02	Lo byte of requested number of registers.	
7	CRC Lo	CRC Lo byte	16 bit CRC, Data validation code
8	CRC Hi	CRC Hi byte	

3. 3. Command 04 (Read Input Register)

Command 04 works in similar way as command 03 except it reads input registers like counts Co, Cb, Ct and Act.Pst which are the process parameters, instead of programmable parameters like in command 03. The query and response is exactly same as command 03, except that the command field will have 04 instead of 03 and the data transaction will be related to input registers instead of holding registers. The process parameters like Co,Cb,Ct and Act.Pst can not be edited.

Following is the Modbus Address Table for Input registers:-

Address Max Count 6	Address Max Count 6S	Description	Remarks
30000	30000	Co Hi	MSB of the main counter
30001	30001	Co Lo	LSB of the main counter
30002	30002	Cb Hi	MSB of the Batch counter
30003	30003	Cb Lo	LSB of the Batch counter
30004	30004	Ct Hi	MSB of the Totalizer
30005	30005	Ct Lo	LSB of the Totalizer
N.A.	30006	Act. Pst. Hi	MSB of the Active Preset.
N.A.	30007	Act. Pst. Lo	LSB of the Active Preset

Following is the Modbus Address Table for Holding registers:-

Address Max Count 6	Address Max Count 6S	Description	Remarks
40000	40000	Start Count Hi	MSB of the Start count .The start count value should not exceed 999999(F423Fh). If the value exceeds the start count will be replaced by the default value 000000.
40001	40001	Start Count Lo	LSB of the Start count.
N.A.	40002	Early warn preset Hi	MSB of the Early warn preset. The value should not exceed 99999(F423Fh). If the value exceeds, the Early warn preset will be replaced by the default value 000000.
N.A.	40003	Early warn preset Lo	LSB of the Early warn preset.
40002	40004	Preset 1 Hi	MSB of the Numeric value of the Preset 1. The preset 1 value should not exceed 999999(F423Fh). If the value exceeds the Preset 1, it will be replaced by the default value 000000.
40003	40005	Preset 1 Lo	LSB of the Numeric value of the Preset 1. The preset 1 value should not exceed 999999(F423Fh). If the value exceeds the Preset 1, it will be replaced by the default value 000000.
40004	40006	Preset 2 Hi	MSB of the Numeric value of the Preset 2.
40005	40007	Preset 2 Lo	LSB of the Numeric value of the Preset 2.

Address Max Count 6	Address Max Count 6S	Description	Remarks
40006	40008	Preset 3 Hi	MSB of the Numeric value of the Preset 3. .
40007	40009	Preset 3 Lo	LSB of the Numeric value of the Preset 3.
40008	40010	Preset 4 Hi	MSB of the Numeric value of the Preset 4.
40009	40011	Preset 4 Lo	LSB of the Numeric value of the Preset 4.
40010	40012	Preset 5 Hi	MSB of the Numeric value of the Preset 5.
40011	40013	Preset 5 Lo	LSB of the Numeric value of the Preset 5.
40012	40014	Preset 6 Hi	MSB of the Numeric value of the Preset 6.
40013	40015	Preset 6 Lo	LSB of the Numeric value of the Preset 6.
40014	40016	Preset 7 Hi	MSB of the Numeric value of the Preset 7.
40015	40017	Preset 7 Lo	LSB of the Numeric value of the Preset 7.
40016	40018	Preset 8 Hi	MSB of the Numeric value of the Preset 8.
40017	40019	Preset 8 Lo	LSB of the Numeric value of the Preset 8.
40018	40020	Preset 9 Hi	MSB of the Numeric value of the Preset 9.
40019	40021	Preset 9 Lo	LSB of the Numeric value of the Preset 9.
40020	40022	Preset 10 Hi	MSB of the Numeric value of the Preset 10.
40021	40023	Preset 10 Lo	LSB of the Numeric value of the Preset 10.
40022	40024	Preset 11 Hi	MSB of the Numeric value of the Preset 11.
40023	40025	Preset 11 Lo	LSB of the Numeric value of the Preset 11.
40024	40026	Preset 12 Hi	MSB of the Numeric value of the Preset 12.
40025	40027	Preset 12 Lo	LSB of the Numeric value of the Preset 12.
40026	40028	Preset 13 Hi	MSB of the Numeric value of the Preset 13.
40027	40029	Preset 13 Lo	LSB of the Numeric value of the Preset 13.
40028	40030	Preset 14 Hi	MSB of the Numeric value of the Preset 14.
40029	40031	Preset 14 Lo	LSB of the Numeric value of the Preset 14.

Address Max Count 6	Address Max Count 6S	Description	Remarks
40030	40032	Preset 15 Hi	MSB of the Numeric value of the Preset 15.
40031	40033	Preset 15 Lo	LSB of the Numeric value of the Preset 15.
40032	40034	Preset 16 Hi	MSB of the Numeric value of the Preset 16.
40033	40035	Preset 16 Lo	LSB of the Numeric value of the Preset 16.
Note: For Presets 2 to 16, the remarks will remain same as explained for preset 1			
40034	40036	Batch Preset Hi / *Cycle Batch Preset Hi	MSB of the Numeric value of the Batch Preset assignment. The Batch preset assignment value should not exceed 999999(F423Fh). If the value exceeds the Batch Preset assignment will be replaced by the default value 000000.
40035	40037	Batch Preset Lo / *Cycle Batch Preset Lo	LSB of the Numeric value of the Batch Preset assignment. The Batch preset assignment value should not exceed 999999(F423Fh). If the value exceeds the Batch Preset assignment will be replaced by the default value 000000.
40036	40038	Correction Cnst Hi	MSB of Correction Constant. The Correction Constant value should not exceed 99999(1869Fh). If the value exceeds, the Correction Constant value will be replaced by the default value 10000.
40037	40039	Correction Cnst Lo	LSB of Correction Constant. The Correction Constant value should not exceed 99999(1869Fh). If the value exceeds, the Correction Constant value will be replaced by the default value 10000
40038	40040	Input Mode Hi	MSB of the Numeric value used to select the A-B, A+B X1 for open collector or contact inputs: selects A-B, A+B X2 or Quadrature X2, X4 for open collector inputs. The Input mode value should not exceed 7. If the value exceeds it will be loaded with A-B_CONTACT_X1.
40039	40041	Input Mode Lo	LSB of the Numeric value used to select the A-B, A+B X1 for open collector or contact inputs: selects A-B, A+B X2 or Quadrature X2, X4 for open collector inputs. The Input mode value should not exceed 7 If the value exceeds it will be loaded with A-B_CONTACT_X1.
40040	40042	Count Dir Hi	MSB of the count direction. The value of the count direction is either 0(DIRECTION_UP) or 1(DIRECTION_DOWN). If the value given is greater then 1, then the default value of 0(DIRECTION_UP) is loaded.
40041	40043	Count Dir Lo	LSB of the count direction. The value of the count direction is either 0(DIRECTION_UP) or 1(DIRECTION_DOWN). If the value given is greater then 1, then the default value of 0(DIRECTION_UP) is loaded

Address Max Count 6	Address Max Count 6S	Description	Remarks
40042	40044	Decimal Point Hi	MSB of the Decimal point position for count, Total count and presets. The value of Decimal point position should not exceed 4 .If the value exceeds 4, it will be replaced by 0.
40043	40045	Decimal Point Lo	LSB of the Decimal point position for count, Total count and presets. The value of Decimal point position should not exceed 4 .If the value exceeds 4, it will be replaced by 0.
40044	40046	Front Panel Rst Hi	MSB of the Numeric value used to select the Front Panel reset. The value can be either 0(FRNT_PANL_RST_OFF) or 1(FRNT_PANL_RST_ON). If the value exceeds 1, the default value of 0 is loaded.
40045	40047	Front Panel Rst Lo	LSB of the Numeric value used to select the Front Panel reset. The value can be either 0(FRNT_PANL_RST_OFF) or 1(FRNT_PANL_RST_ON). If the value exceeds 1, the default value of 0 is loaded.
40046	40048	Counter Ret. Hi	MSB of the Numeric value used to select the Counter retention. The value can be either 0(CNTR_RETN_OFF) or 1(CNTR_RETN_ON). If the value exceeds 1, the default value of 0 is loaded.
40047	40049	Counter Ret. Lo	LSB of the Numeric value used to select the Counter retention. The value can be either 0(CNTR_RETN_OFF) or 1(CNTR_RETN_ON). If the value exceeds 1, the default value of 0 is loaded.
40048	40050	Preset Lock Hi	MSB of the Numeric value used to select the editable option of the set up mode parameters. The value can be either 0(PRST_LOC_OFF) or 1(PRST_LOC_ON). If the value exceeds 1, the default value of 0 is loaded.
40049	40051	Preset Lock Lo	LSB of the Numeric value used to select the editable option of the set up mode parameters. The value can be either 0(PRST_LOC_OFF) or 1(PRST_LOC_ON). If the value exceeds 1, the default value of 0 is loaded.
40050	40052	Total Count Enable Hi	MSB of the Numeric value used to select the Totalizer counter enable. The value can be either 0(TOTAL_OFF) or 1(TOTAL_ON). If the value exceeds 1, the default value of 0 is loaded.
40051	40053	Total Count Enable Lo	LSB of the Numeric value used to select the Totalizer counter enable. The value can be either 0(TOTAL_OFF) or 1(TOTAL_ON). If the value exceeds the default value of 0 is loaded.

Address Max Count 6	Address Max Count 6S	Description	Remarks
40052	N.A.	Stop/ Hold Hi	MSB of the Numeric value used to select the Stop count or display Hold function. The value can be 0(STOP_MODE), 1(HOLD_MODE) or 2(INC_PST). If the value exceeds 2, the default value of 0(STOP_MODE) is loaded.
40053	N.A.	Stop/ Hold Lo	LSB of the Numeric value used to select the Stop count or display Hold function. The value can be 0(STOP_MODE), 1(HOLD_MODE) or 2(INC_PST). If the value exceeds 2, the default value of 0(STOP_MODE) is loaded.
N.A.	40054	Stop/ Hold/ Inc Pst Hi	MSB of the Numeric value used to select the Stop count or display Hold function or Increment preset via external input. The value can be 0(STOP_MODE), 1(HOLD_MODE) or 2(INC_PST). If the value exceeds 2, the default value of 0(STOP_MODE) is loaded.
N.A.	40055	Stop/ Hold/ Inc Pst Lo	LSB of the Numeric value used to select the Stop count or display Hold function or Increment preset via external input. The value can be 0(STOP_MODE), 1(HOLD_MODE) or 2(INC_PST). If the value exceeds 2, the default value of 0(STOP_MODE) is loaded.
N.A.	40056	Output Control/ Dec Hi	MSB of the Numeric value used to select the Output control or Decrement preset via external input. The value can be either 0(OUTPUT_CNTRL) or 1(DEC_PST). If the value exceeds 1, the default value of 0 is loaded.
N.A.	40057	Output Control/ Dec Lo	LSB of the Numeric value used to select the Output control or Decrement preset via external input. The value can be either 0(OUTPUT_CNTRL) or 1(DEC_PST). If the value exceeds 1, the default value of 0 is loaded.
40054	N.A.	Batch/ Total Rst Hi	MSB of the Numeric value used to select the Batch count, Totalizer. The value can be 0(BATCH_RST), 1(TOTAL_RST). If the value exceeds 1, the default value of 0 is loaded.
40055	N.A.	Batch/ Total/ Rst Lo	LSB of the Numeric value used to select the Batch count, Totalizer. The value can be 0(BATCH_RST), 1(TOTAL_RST). If the value exceeds 1, the default value of 0 is loaded.
N.A.	40058	Batch/ Total/ Cycle Rst Hi	MSB of the Numeric value used to select the Batch count, Totalizer or cycle reset via external input. The value can be 0(BATCH_RST), 1(TOTAL_RST) or 2(CYCLE_RST). If the value exceeds 2, the default value of 0 is loaded.
N.A.	40059	Batch/ Total/ Cycle Rst Lo	LSB of the Numeric value used to select the Batch count, Totalizer or cycle reset via external input. The value can be 0(BATCH_RST), 1(TOTAL_RST) or 2(CYCLE_RST). If the value exceeds 2, the default value of 0 is loaded.

Address Max Count 6	Address Max Count 6S	Description	Remarks
40056	40060	Out_1 Hi	MSB of the Numeric value used to select the latched or pulsed operation of Output 1. If the value is non-zero it is pulsed operation. The value should not exceed 9999(270Fh). If the value exceeds 9999, the output 1 value will be replaced by the default value 0000(Latched operation).
40057	40061	Out_1 Lo	LSB of the Numeric value used to select the latched or pulsed operation of Output 1. If the value is non-zero it is pulsed operation. The value should not exceed 9999(270Fh). If the value exceeds 9999, the output 1 value will be replaced by the default value 0000(Latched operation).
40058	40062	Out_2 Hi	MSB of the Numeric value used to select the latched or pulsed operation of Output 2.
40059	40063	Out_2 Lo	LSB of the Numeric value used to select the latched or pulsed operation of Output 2.
40060	40064	Out_3 Hi	MSB of the Numeric value used to select the latched or pulsed operation of Output 3.
40061	40065	Out_3 Lo	LSB of the Numeric value used to select the latched or pulsed operation of Output 3.
40062	40066	Out_4 Hi	MSB of the Numeric value used to select the latched or pulsed operation of Output 4.
40063	40067	Out_4 Lo	LSB of the Numeric value used to select the latched or pulsed operation of Output 4.
40064	40068	Out_5 Hi	MSB of the Numeric value used to select the latched or pulsed operation of Output 5.
40065	40069	Out_5 Lo	MSB of the Numeric value used to select the latched or pulsed operation of Output 5.
40066	40070	Out_6 Hi	MSB of the Numeric value used to select the latched or pulsed operation of Output 6.
40067	40071	Out_6 Lo	LSB of the Numeric value used to select the latched or pulsed operation of Output 6.

Note: For Outputs 2 to 6, the remarks will remain same as explained for Output 1

Address Max Count 6	Address Max Count 6S	Description	Remarks
40068	40072	P1_Assign Hi	MSB of the Numeric value used to assign preset 1. In this Menu '-' refers to 1, 'p' refers to 2 and 'd' refers to 3. The first integer(LSB) refers to Output 1, 2 nd refers to output 2, 3 rd refers to output 3, 4 th refers to output 4, 5 th refers to output 5, 6 th refers to output 6. For example to pickup 1 st , 3 rd and 4 th outputs, then the value to be given is 112212. Its hex equivalent is 1B654h. If any integer that is referring to any of the output exceeds 3, then all the integers are loaded with 111111(1B207h).
40069	40073	P1_Assign Lo	LSB of the Numeric value used to assign preset 1. In this Menu '-' refers to 1, 'p' refers to 2 and 'd' refers to 3. The first integer(LSB) refers to Output 1, 2 nd refers to output 2, 3 rd refers to output 3, 4 th refers to output 4, 5 th refers to output 5, 6 th refers to output 6. (Example same as mentioned for P1_Assign Hi, Address 40068)
40070	40074	P2_Assign Hi	MSB of the Numeric value used to assign preset 2.
40071	40075	P2_Assign Lo	LSB of the Numeric value used to assign preset 2.
40072	40076	P3_Assign Hi	MSB of the Numeric value used to assign preset 3.
40073	40077	P3_Assign Lo	LSB of the Numeric value used to assign preset 3.
40074	40078	P4_Assign Hi	LSB of the Numeric value used to assign preset 4.
40075	40079	P4_Assign Lo	LSB of the Numeric value used to assign preset 4.
40076	40080	P5_Assign Hi	MSB of the Numeric value used to assign preset 5.
40077	40081	P5_Assign Lo	LSB of the Numeric value used to assign preset 5.
40078	40082	P6_Assign Hi	MSB of the Numeric value used to assign preset 6.
40079	40083	P6_Assign Lo	LSB of the Numeric value used to assign preset 6.
40080	40084	P7_Assign Hi	MSB of the Numeric value used to assign preset 7.
40081	40085	P7_Assign Lo	LSB of the Numeric value used to assign preset 7.
40082	40086	P8_Assign Hi	MSB of the Numeric value used to assign preset 8.
40083	40087	P8_Assign Lo	LSB of the Numeric value used to assign preset 8.
40084	40088	P9_Assign Hi	MSB of the Numeric value used to assign preset 9.
40085	40089	P9_Assign Lo	LSB of the Numeric value used to assign preset 9.
40086	40090	P10_Assign Hi	MSB of the Numeric value used to assign preset 10.

Address Max Count 6	Address Max Count 6S	Description	Remarks
40087	40091	P10_Assign Lo	LSB of the Numeric value used to assign preset 10.
40088	40092	P11_Assign Hi	MSB of the Numeric value used to assign preset 11.
40089	40093	P11_Assign Lo	LSB of the Numeric value used to assign preset 11.
40090	40094	P12_Assign Hi	MSB of the Numeric value used to assign preset 12.
40091	40095	P12_Assign Lo	LSB of the Numeric value used to assign preset 12.
40092	40096	P13_Assign Hi	MSB of the Numeric value used to assign preset 13.
40093	40097	P13_Assign Lo	LSB of the Numeric value used to assign preset 13.
40094	40098	P14_Assign Hi	MSB of the Numeric value used to assign preset 14.
40095	40099	P14_Assign Lo	LSB of the Numeric value used to assign preset 14.
40096	40100	P15_Assign Hi	MSB of the Numeric value used to assign preset 15.
40097	40101	P15_Assign Lo	LSB of the Numeric value used to assign preset 15.
40098	40102	P16_Assign Hi	MSB of the Numeric value used to assign preset 16.
40099	40103	P16_Assign Lo	LSB of the Numeric value used to assign preset 16.
<p>Note: For Preset Assignments P2 to P16, the remarks will remain same as explained for Preset Assignment P1</p>			
40100	40104	Rst_Input_Assign Hi	MSB of the Numeric value used to assign reset input. In this Menu '-' refers to 1, 'p' refers to 2 and 'd' refers to 3. The first integer(LSB) refers to Output 1, 2 nd refers to output 2, 3 rd refers to output 3, 4 th refers to output 4, 5 th refers to output 5, 6 th refers to output 6. (Example same as mentioned for P1_Assign Hi, Address 40068)
40101	40105	Rst_Input_Assign Lo	LSB of the Numeric value used to assign reset input. In this Menu '-' refers to 1, 'p' refers to 2 and 'd' refers to 3. The first integer(LSB) refers to Output 1, 2 nd refers to output 2, 3 rd refers to output 3, 4 th refers to output 4, 5 th refers to output 5, 6 th refers to output 6. (Example same as mentioned for P1_Assign Hi, Address 40068)
40102	40106	Out_Ctrl_Assign Hi	MSB of the Numeric value used to assign reset control. In this Menu '-' refers to 1, 'p' refers to 2 and 'd' refers to 3. The first integer(LSB) refers to Output 1, 2 nd refers to output 2, 3 rd refers to output 3, 4 th refers to output 4, 5 th refers to output 5, 6 th refers to output 6. (Example same as mentioned for P1_Assign Hi, Address 40068)

Address Max Count 6	Address Max Count 6S	Description	Remarks
40103	40107	Out_Ctrl_Assign Lo	LSB of the Numeric value used to assign reset control. In this Menu '-' refers to 1, 'p' refers to 2 and 'd' refers to 3. The first integer (LSB) refers to Output 1, 2 nd refers to output 2, 3 rd refers to output 3, 4 th refers to output 4, 5 th refers to output 5, 6 th refers to output 6. (Example same as mentioned for P1_Assign Hi, Address 40068)
40104	40108	Baud_Select Hi	MSB of the Numeric value. Default value is 0.(NBD)
40105	40109	Baud_Select Lo	LSB of the Numeric value used to select the Baud rate for Serial communication. The value can not exceed 4.If the value exceed the default value 0 is loaded which terminates the communication.
40106	40110	Serial_ID Hi	MSB of the Numeric value. Default value is 0.(NBD)
40107	40111	Serial_ID Lo	LSB of the Numeric value used to program the serial address. The value should be 1-32. If the value exceeds 32, the Serial ID will be replaced by 32.
40108	40112	Presets On/Off Hi	MSB mentioning On/Off of the presets. '0' represents Off and '1' represents On. First bit position of the register (MSB of Preset on/off register) represents batch preset on/off, 2 nd bit represents early warn preset and the remaining bits of MSB are reserved are reserved. For example, 0000 0000 0000 0011 (0x03 in MSB of Preset on/off register) represents batch preset and early warn presets are set on.
40109	40113	Presets On/Off Lo	LSB mentioning On/Off of the presets. '0' represents Off and '1' represents On. First bit position of the register (LSB) represents preset 1, second bit position represents preset 2, 3 rd represents preset 3, 4 th represents preset 4, 5 th represents preset 5, 6 th represents preset 6, 7 th represents preset 7, 8 th represents preset 8, 9 th represents preset 9, 10 th represents preset 10, 11 th represents preset 11, 12 th represents preset 12, 13 th represents preset 13, 14 th represents preset 14, 15 th represents preset 15, 16 th represents preset 16. For example to make the presets 1,3,4,5 on and remaining off, set the register to 0000 0000 0011 0101 (0x35).
40110	40114	Presets Auto-reset Hi	MSB of the Numeric value. Default value is 0.(NBD)
40111	40115	Presets Auto-reset Lo	LSB mentioning the auto reset for the presets. '0' represents OFF, and '1' represents ON. First bit position of the register (LSB) represents preset 1, second bit position represents preset 2, 3 rd represents preset 3, 4 th represents preset 4, 5 th represents preset 5, 6 th represents preset 6, 7 th represents preset 7, 8 th represents preset 8, 9 th represents preset 9, 10 th represents preset 10, 11 th represents preset 11, 12 th represents preset 12, 13 th represents preset 13, 14 th represents preset 14, 15 th represents preset 15, 16 th represents preset 16. For example to make the presets 1,3,4,5 auto-reset and remaining off, set the register to 0000 0000 0011 0101 (0x35).

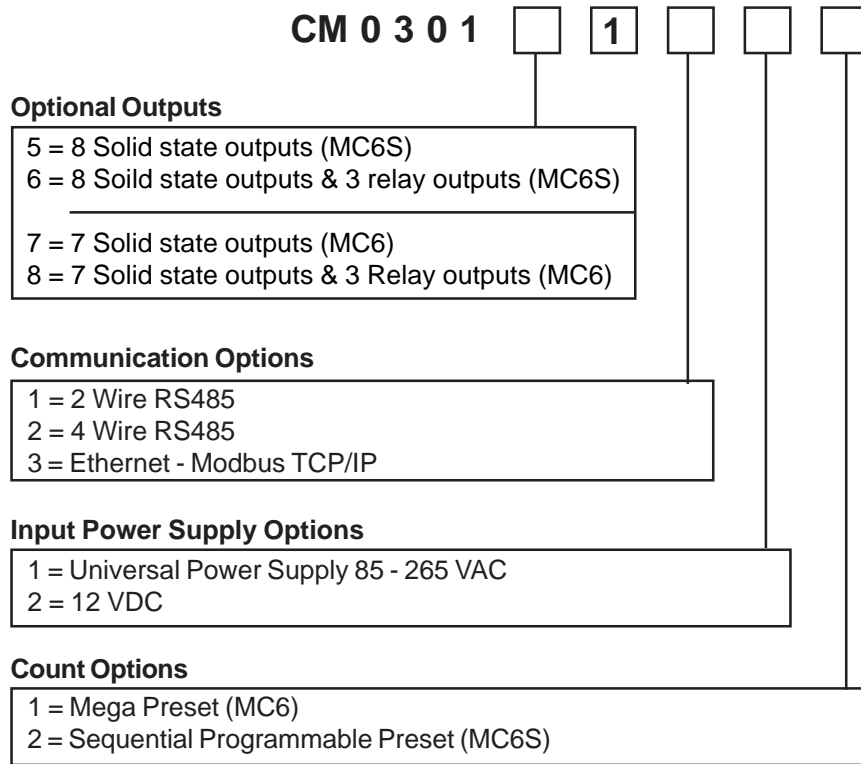

WARRANTY

Standard products manufactured by the Company are warranted to be free from workmanship and material for a period of one year from the date of shipment, and products which are defective in workmanship or material will be repaired or replaced, at the option of the Company, at no charge to the buyer. Final determination as to whether a product is actually defective rests with the company. The obligation of the company hereunder shall be limited solely to repair and replacement of products that fall within the foregoing limitations, and shall be conditioned upon receipt by the company of written notice of any alleged defects or deficiency promptly after discovery within the warranty period, and in the case of components or units purchased by the company, the obligation of the company shall not exceed the settlement that the company is able to obtain from the supplier thereof. No products shall be returned to the company without its prior consent. Products which the company consents to have returned shall be shipped F.O.B. the Company's factory. The Company cannot assume responsibility or accept invoices for unauthorized repairs to its components, even though defective. The life of the products of the Company depends, to a large extent, upon the type of usage thereof, and THE COMPANY MAKES NO WARRANTY AS TO FITNESS OF ITS PRODUCTS FOR SPECIFIC APPLICATIONS BY THE BUYER NOR AS TO PERIOD OF SERVICE UNLESS THE COMPANY SPECIFICALLY AGREES OTHERWISE IN WRITING AFTER THE PROPOSED USAGE HAS BEEN MADE KNOWN TO IT.

THE FOREGOING WARRANTY IS EXCLUSIVE AND IN LIEU OF ALL OTHER WARRANTIES EXPRESSED OR IMPLIED, INCLUDING, BUT NOT LIMITED TO ANY WARRANTY OF MERCHANTABILITY OR OF FITNESS FOR A PARTICULAR PURPOSE.

SERVICE

If this product requires service, call Eagle Signal for an RMA (Return Material Authorization) number, pack it in a sturdy carton and ship prepaid to: Service Dept. at address below.

- Include**
1. Description of the problem
 2. Name of the responsible person
 3. Purchase order number
 4. Return shipping instructions.

Eagle Signal Controls 2100 W Broad St. P.O. Box 368, Elizabethtown, NC 28337
 TEL : 1800-390-6405 FAX: 910-879-5486

Printed in U.S.A