

Robertshaw Vibration Protection Systems

SF-804

Robertshaw
INDUSTRIAL PRODUCTS DIVISION



invensys.

vibration instrumentation by Robertshaw

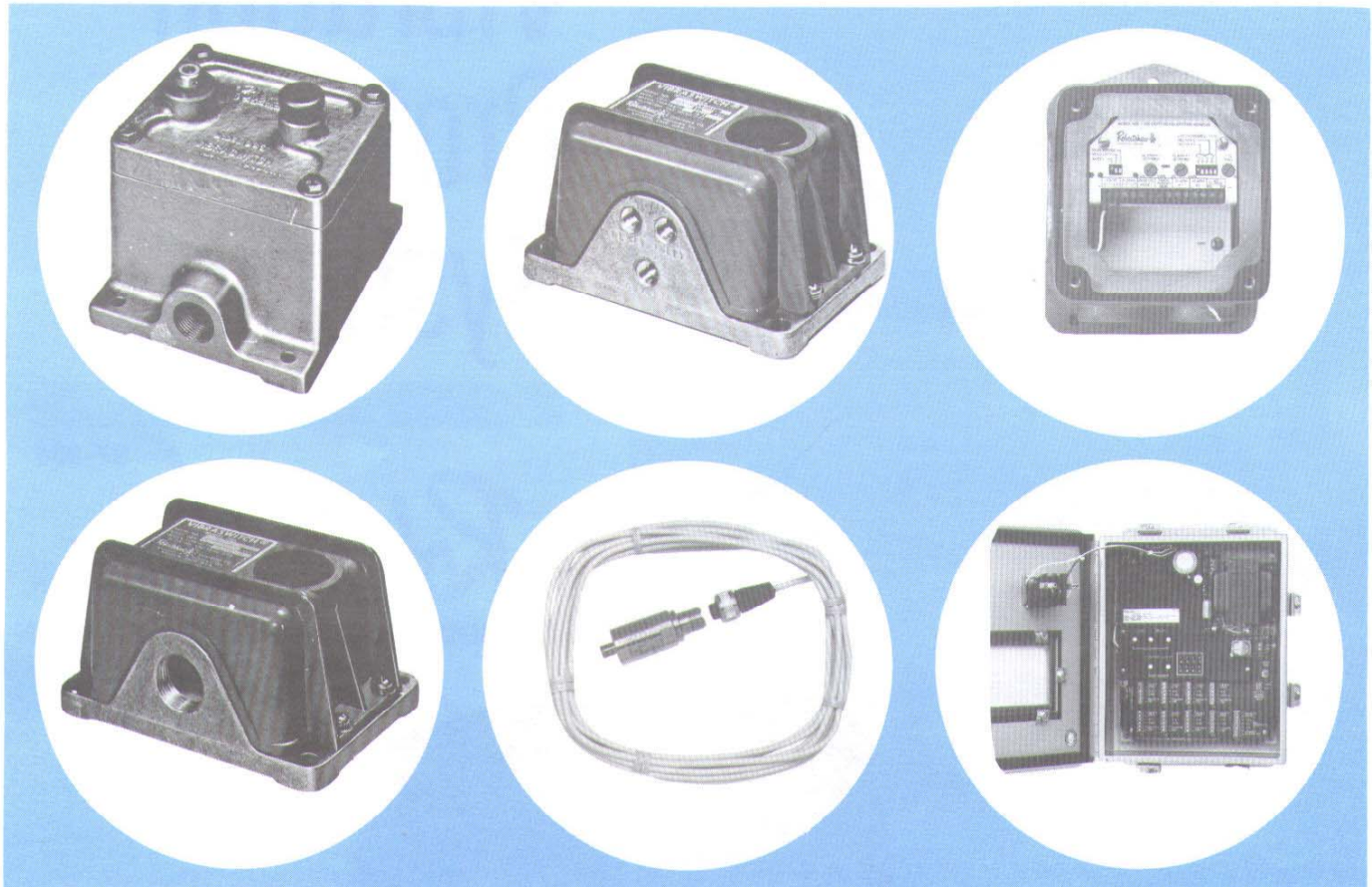

VIBRASWITCH UNITS

On-off instruments for control and alarm on excessive machine vibration.

UNDERSTANDING THE PHYSICAL CHARACTERISTICS OF VIBRATION

Many people are aware that the amplitude (displacement) of a machine, resulting from a vibrating force, is a critical factor in causing mechanical damage to operating machinery. But many people are not aware that the FREQUENCY at which the vibratory force is occurring is of even greater importance in causing mechanical damage.

In general terms, vibration can be described as "... mechanical motion or oscillation about a reference point of equilibrium." To some this may only mean "movement," while to others it might suggest both movement and the relative number of movements per unit of time. To most people it may help to describe, on an operating machine, a condition indicating impending danger when the "vibration" appears to be exceeding a level previously considered normal.

VIBRA-TEL AND CONTROL UNITS

Continuous indicators for alarm and control and Vibraswitch monitoring control units.

DEFINITIONS OF TERMS

Four simple terms are most frequently used in discussing vibration. These are:

1. *Displacement.* Also known as "amplitude" is defined as the magnitude of the motion under study, generally measured as peak-to-peak or double amplitude in "mils" (thousandths of an inch). These measurements are most important in the study of deformation or bending of structures.
2. *Velocity.* The time rate of change of displacement, which is the first derivative of displacement with respect to time. Velocity measurements are most important where the noise from vibration is of greatest importance.
3. *Acceleration.* The second derivative of displacement with respect to time. Its magnitude is proportional to displacement and the square of frequency. These measurements are most practical and important where actual mechanical failure of parts is possible. The unit of measurement is "gravity" abbreviated by the letter G. The formula is $G = KAF^2$, where

K is a numerical constant
 A is the amplitude of motion
 F is the frequency at which the amplitude (displacement) is occurring.

Note that the total G forces (the destructive shock acting upon the bearings, shafts, etc.) varies directly with the amplitude (A) but with the SQUARE of the frequency (F). Therefore, doubling the amplitude (A) will double the destructive shock; while doubling the frequency (F) will increase the destructive shock by four times.

WHY MONITOR ACCELERATORY VIBRATION?

Figure 1 shows the resultant wave form of displacement with respect to time of a pure harmonic motion producing a sinusoidal single frequency wave form. Robertshaw vibration instruments measure the total acceleratory forces (shock) and are therefore responsive to both amplitude and frequency of the resultant vibration. Vibration instruments that are responsive only to amplitude (displacement) are unable to detect the total destructive "forces" (i.e. "G's") that will tear costly equipment apart.

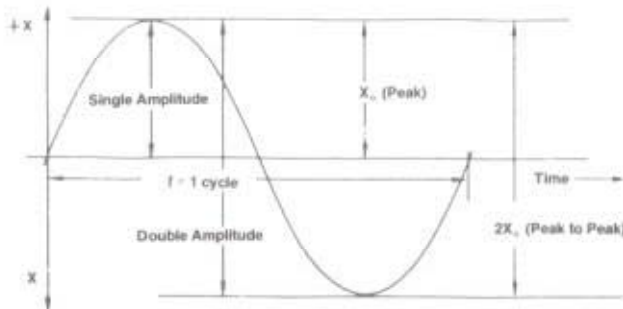

Figure 1

The resultant wave shape of displacement with respect to time of pure harmonic motion — sinusoidal single frequency.

It is important to remember these points:

1. The fact that a particular point on a machine is being displaced offers little information in regards to its destructive forces.
2. Acceleration measured at a particular point on a machine indicates the TOTAL vibratory shock and, therefore, offers a useful figure of merit of the total destructive forces present.
3. Operating machines' vibrations seldom follow pure harmonic motions at a single frequency, but rather they are combinations of a fundamental frequency (basic machine speed) and a number of higher harmonic frequencies. Since such vibrations result in a complex wave form (non-sinusoidal), *acceleration* sensing instruments offer the best measure of these destructive vibratory forces.

TYPICAL INSTALLATION ON A MACHINE

The photograph illustrates an installation of a Robertshaw Vibra-switch on a reciprocating compressor. The sensing unit (detector) is placed on the machine in a location that will permit the unit to be responsive to excessive and damaging vibration. In this application the detector is mounted on a heavy bracket which in turn is rigidly bolted to a heavy inspection cover located opposite the main crank shaft and bearings of the compressor. In this location the Vibra-switch will detect any excessive vibration due to bearing wear or loose parts associated with either of the two compressor pistons and their connecting rods which are driven by the main crank shaft.

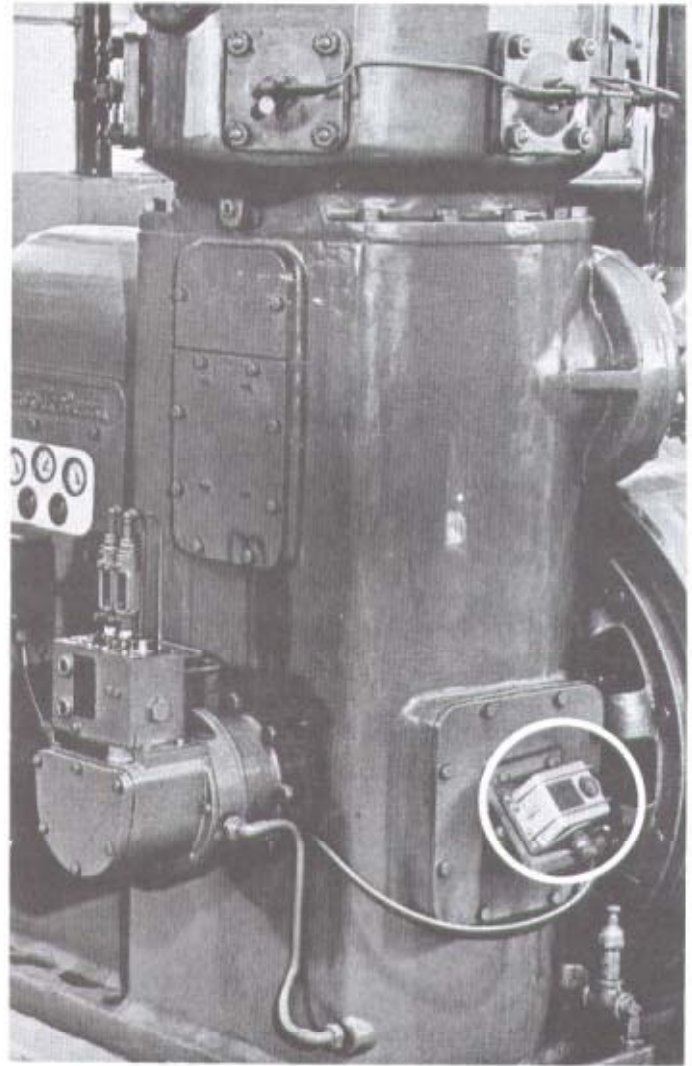

Typically, the detecting element is placed as close to the bearing assemblies, crank shafts, driven gears, and other rotating or reciprocating parts as possible in order to be responsive to malfunctions of these parts.

APPLICATIONS

Nearly all rotating or reciprocating machines are candidates for vibration measuring and control or alarm instrumentation. The following list of machines are typical:

FANS	GRINDERS
BLOWERS	ALTERNATORS
CENTRIFUGES	COMPRESSORS
TURBINES	MOTORS
ENGINES	GENERATORS
MILLS	GEAR BOXES

The types of failures these machines typically suffer most often are:

BEARINGS	GEAR TEETH
CONNECTING RODS	SEALS
PUMP IMPELLERS	MOTOR WINDINGS
DRIVE SHAFT COUPLINGS	CAVITATING PUMPS
LUBRICATING SYSTEMS	DIRT-LADEN FANS
VALVES AND VALVE LIFTERS	FRACTURED BELTS
PISTONS AND RINGS	MOTOR ARMATURES
TURBINE BLADES	PART SHIFTING
BELTS AND CHAINS	

vibraswitch® vibration sensors

THE SOPHISTICATED INSTRUMENTATION FOR DETECTING MACHINE MALFUNCTIONS

PROTECTS YOUR EQUIPMENT FROM DESTRUCTIVE VIBRATION

The Robertshaw Vibraswitch offers many features not usually available in competitive vibration instruments. Some of these features are:

1. Models are available with ELECTRIC or PNEUMATIC switching action.
2. Units respond to the DESTRUCTIVE forces, not displacement.
3. No MAINTENANCE required, no moving parts to wear insures long life.
4. CONTINUOUS PROTECTION for operating machines.

There are more than 125,000 Robertshaw Vibraswitches in use all over the world making these instruments by far the most widely used vibration detection system available.

HOW THE VIBRASWITCH OFFERS POSITIVE PROTECTION

Figure 2 is a line diagram of the basic operating principle. The detector mechanism consists of an armature (pendulous mass) suspended on a flexure pivoted beam. It is restrained from motion in its normal (reset) condition by means of a permanent hold-down magnet acting through a small air gap. A compression spring provides an adjustable force opposing the magnetic force and this serves as the adjustable SET-POINT which is calibrated directly in G's (acceleration units). The armature acts as a beam: it is forced in one direction by the adjustable spring, and in the other direction it is balanced by the magnetic force as indicated in Figure 2.

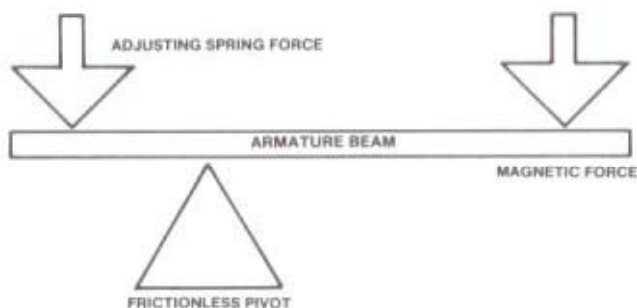

Figure 2
Basic Operating Principle

The armature is constrained to a single direction of movement (sensitive axis) by using a relatively wide flexure pivot assembly composed of two overlapping blocks and a leaf spring loaded in one direction so as to hold the blocks together as shown in Figure 3.

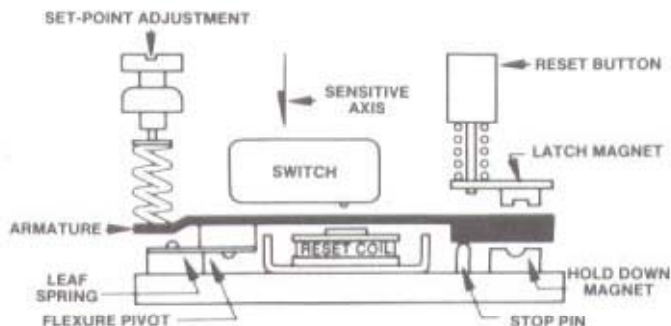

Figure 3
Model 365/366 Electric Vibraswitch

When the entire assembly is subjected to vibration perpendicular to the base, the peak acceleration (A) times the effective mass (M) of the armature produces an inertial force ($F = MA$). This force is aided by the spring, which tends to pull the armature away from the hold-down magnet and the stop pin. When the peak acceleration exceeds a pre-selected set-point level, the armature leaves the stop pin, and moves up to the latch magnet, which holds it in the "alarm" (excess vibration) position until it is reset.

Motion of the armature actuates a snap-action switch, either an electrical or pneumatic type, which signals that the set-point has been exceeded. The Vibraswitch is an accurate and dependable but simple mechanical accelerometer with "on-off" control output.

To the basic design the following refinements are added:

1. *Temperature Compensation.* The effect of temperature in the mechanism is negligible as the elastic modulus of the adjustment spring and the magnetic flux through the air gaps both decrease slightly with increasing temperature; these two effects are, therefore, compensating.
2. *Set-Point Adjustment.* This screw allows setting the force on the spring-loaded end of the armature to compensate for "normal" machine vibration plus the desired "safety" factor of the particular machine involved. The dials are calibrated directly in G units through a range of 0 to 4.5 G's.
3. *Electric or Pneumatic Reset.* An electromagnet attracts the armature when energized with a voltage, or a pneumatically actuated plunger forces the armature back to the "reset" position. It is used for remote resetting after actuation, and for "locking out" the Vibraswitch during abnormal machine vibrations that may occur during start-up or transient shock conditions.
4. *Manual Reset Button.* This permits manual resetting of the Vibraswitch after actuation (tripping).

Figure 4 shows the basic operating parts of the Model 368 Vibraswitch for operation on pneumatic power. It is basically the same unit as the electric type except for the pneumatic valve assembly.

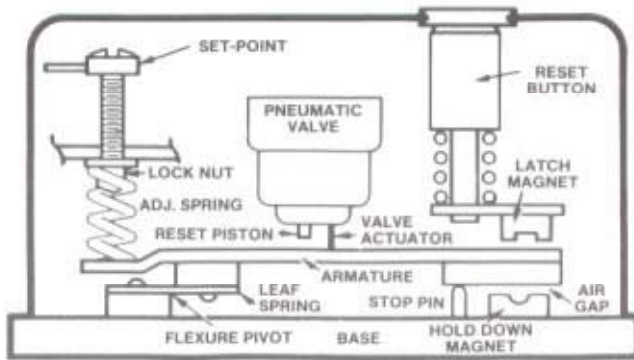

Figure 4
Model 368 Pneumatic Vibraswitch

SIMPLICITY OF INSTALLATION AND ADJUSTMENT

The vibration sensitive axis of the Vibraswitch is in a direction perpendicular to its mounting base. Therefore it must be mounted on the machine in a plane that will detect the vibratory motion for which protection is desired. Normally bent shafts, unbalances on the rotating mass of the shaft, worn bearings, and other mechanical abnormalities are best detected near the bearing housings and at right angles to the rotating shaft. Do not mount the Vibraswitch perpendicular to the ends of rotating shafts unless an end-play or end-thrust measurement of the shaft is desired.

The base must be rigidly mounted on a flat surface so that all four corners of the base are contacting the surface. If a mounting plate is attached to the machine, it must be very rugged in order to prevent introduction of mechanical (plate) resonances into the Vibraswitch.

Adjustment

The set-point is initially adjusted to its maximum G value by turning it fully counterclockwise. If the machine is operating normally (without excessive vibration), slowly turn the set-point clockwise until the switch actuates. Then advance the set-point counterclockwise five divisions on the graduated dial (0.5 G). *Adjustment is then complete.*

TYPICAL VIBRASWITCH INSTALLATIONS

The line drawing shown in Figure 5 indicates typical mounting locations for the Vibraswitch detectors on a multiple unit machine consisting of a diesel engine driving into a gear box which in turn is driving a centrifugal compressor. A Vibraswitch detector is mounted on each of the major units as near the main drive bearings as possible on both the centrifugal compressor and the gear box. The diesel engine is protected by only a single Vibraswitch located at a mid-point on the engine frame; better protection would be afforded with additional detectors mounted on the engine at the ends of the engine near the drive bearings.



RECOMMENDED LOCATIONS

Figure 5
Engine/Gear/Centrifugal Compressor

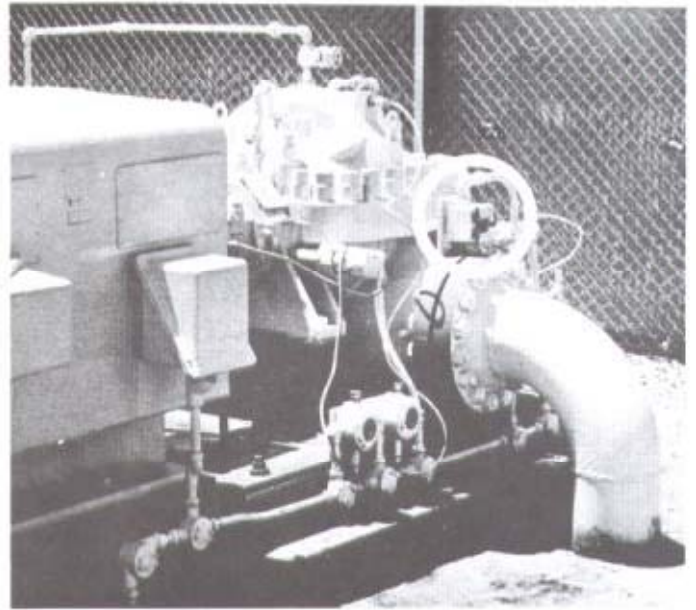

Typical installation of an explosion-proof Vibraswitch on a motor driven centrifugal pumping unit. The circled area indicates the mounting location of the Vibraswitch on the centrifugal pump used in a petrochemical pipeline installation at one of the pumping stations. The drive motor is a 600 hp, 3500 rpm unit driving directly a high pressure centrifugal pump operating at approximately 450 psig pressure.

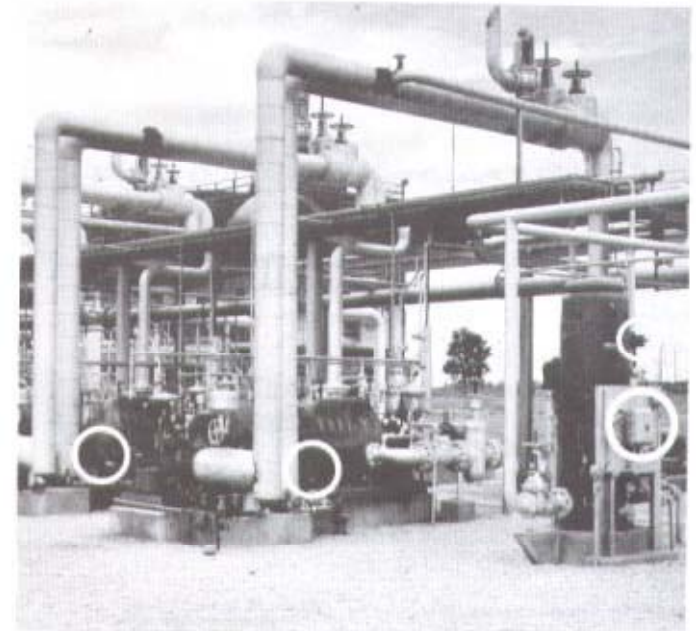

Multiple Vibraswitch installations at a liquefied petroleum gas production facility. The unit circled at the extreme right of the photograph shows an explosion proof Vibraswitch and associated control unit mounted on the motor drive unit of a vertically driven pump. The Vibraswitch is mounted approximately at the motor mid-point so that it will be responsive to any excessive vibration of either the motor or the vertical pump. The motor drive speed is 4500 rpm. The control unit is mounted on a free standing vertical panel along with Start, Stop and Reset switches required by the system.

The circled areas to the center and left of the photograph shows the installation of additional Vibraswitch detectors on motor driven centrifugal pumps at this LPG processing facility.

the Robertshaw models 365 • 366 vibraswitch

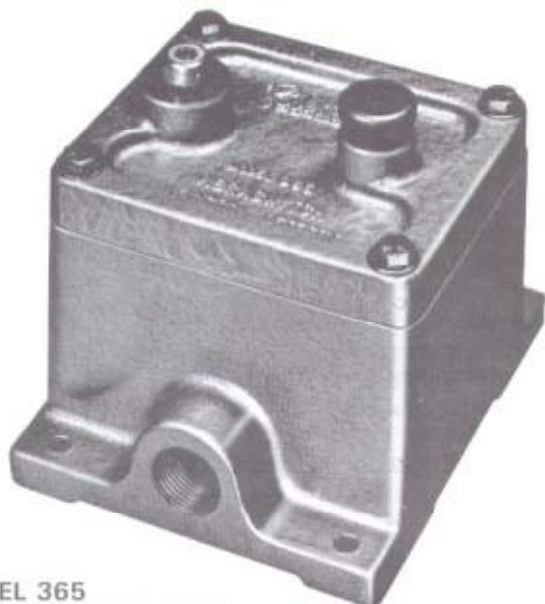

MODEL 365
FM Approved, CSA Certified

The Model 365 Vibraswitch is an acceleration sensitive instrument that measures the total peak vibratory shock (destruction forces) present at the point of measurement. The instrument's explosion proof housing meets Class I, Division 1, Groups C and D, and Class II, Division 1, Groups E, F and G hazardous area classifications. It is FM approved and CSA certified. The instrument provides electrical switch contact closures for on-off control of alarms and shut-down of machines. Both SPDT and DPDT contact arrangements are available.

The set-point is provided with a dial calibrated in 0.1 G divisions. The instrument has a range of 0 to 4.5 G in a frequency range of 0 to 300 Hz. The set-point adjustment resolution is 1 G per turn. The Vibraswitch can be supplied with an electrical reset coil for remote resetting; it is available for voltages of 24, 48, 120VDC or 120 VAC. A manual reset button is supplied as standard equipment on all units.

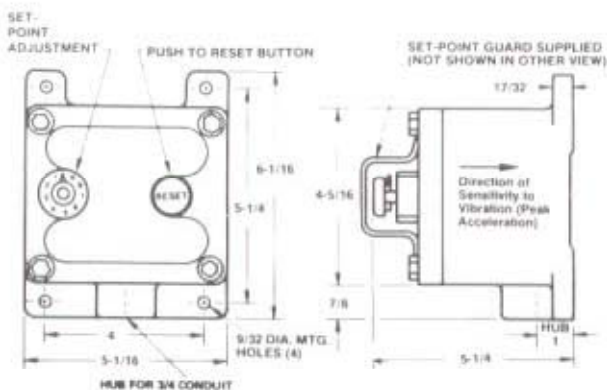

Dimension Data — Model 365



MODEL 366
CSA Certified

The Model 366 Vibraswitch is an acceleration sensitive instrument that measures the total peak vibratory shock (destruction forces) present at the point of measurement. The instrument is housed in a general purpose, weather-resistant enclosure meeting NEMA type 4 specs. The cover is ABS high impact thermoplastic material and the base is aluminum 360 (Cu Free). The Model 366 is CSA certified. It provides electrical switch contact closures for on-off control of alarm and / or shut-down of machines. It is available with SPDT or DPDT contact arrangements.

The set-point is provided with a dial calibrated in 0.1 G divisions. The instrument has a range of 0 to 4.5 G in a frequency range of 0 to 300 Hz. The set-point adjustment resolution is 1 G per turn. The Vibraswitch can be supplied with an electrical reset coil for remote resetting; it is available for voltages of 24, 48, 120 VDC or 120VAC. A manual reset button is supplied as standard equipment on all units.

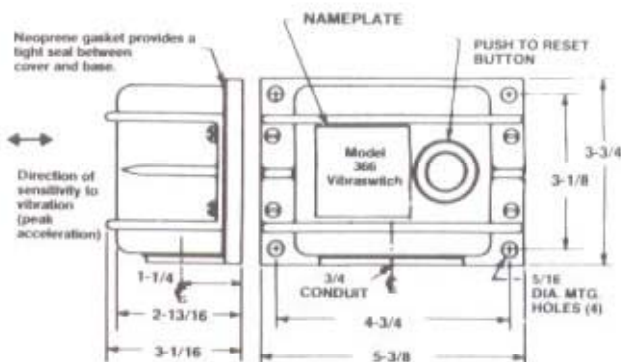

Dimension Data — Model 366

control units & monitors models 563A·566

CONTROL UNIT MODEL 563A

Many machines on which Vibraswitches are installed experience certain non-destructive high-level vibrations during their normal starting and running conditions. Robertshaw has developed a "supervisory" (monitoring) system for use with Model 365 and 366 electric Vibraswitch units. This supervisory instrument is called a MONITOR and/or CONTROL UNIT. The Vibraswitch instruments used with this monitor or control unit must have electrical reset coils.

To better understand the reasons for starting and monitoring time delays, reference to Figure 6 shows typical vibration levels on an operating machine with respect to time. Since some of these vibration levels are higher than the set-point adjustment on the Vibraswitch, the monitor control unit must contain certain supervisory logic that will sort out the false short term disturbances so that alarm and shut-down will not occur; but if a valid (long term) high level vibration occurs, then alarm and shut-down must be initiated.

Refer to Figure 6, periods (1) through (5).

(1) STARTING TIME DELAY — The vibration level did exceed the Vibraswitch set-point. However, the control unit "locked out" the Vibraswitch control contacts during the time delay periods as set on the control unit. Without the starting time delay, the machine would not have reached its normal operating speed because the Vibraswitch would have shut it down prematurely.

(2) NORMAL VIBRATION LEVEL — After the machine reaches its normal operating speed and the vibration level has assumed a level below the set-point value, the Vibraswitch and the control unit are passive. With the average machine in good mechanical condition, the "normal" vibration level will dominate for an indefinite period.

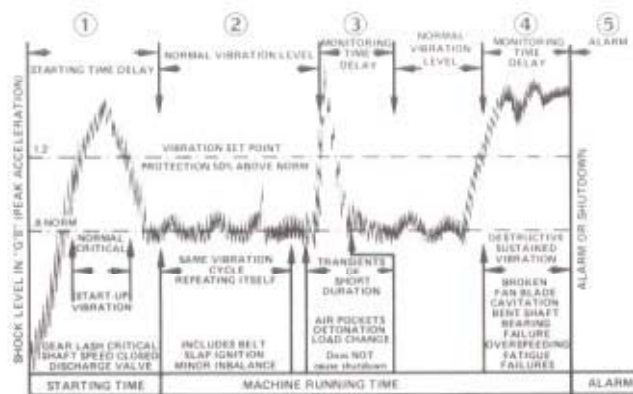

Figure 6
Vibration Levels on Typical Machines

(3) TRANSIENT SHOCKS — Monitoring time delay is used to "sort out" these short duration high level vibrations which are non-destructive to the machine but would cause shut-down. These short duration disturbances are caused by such things as sudden load changes on pipeline pumps, by the sudden closing of diverting valves, check valves or by air pockets in liquid lines, pump cavitation, etc. Each time the set-point has been exceeded by the transient disturbance, the monitoring time delay circuit is energized and the

Vibraswitch is reset and a second "sample" is made to determine if the Vibraswitch requires resetting again. The total monitoring time is adjustable; usually from 2 to 5 seconds are the most popular time settings. If the Vibraswitch set-point is not exceeded, then the control unit remains passive.

(4) DESTRUCTIVE VIBRATION — The sampling and monitoring circuit is energized immediately on high level vibration (above the set-point on the Vibraswitch) and approximately five "samples" will be made during the monitor time period. If all five samples indicate the vibration level was above the set-point, then the monitor circuitry will actuate the alarm or shutdown contacts.

(5) ALARM OR SHUTDOWN — The control unit contacts are locked into the alarm or shutdown conditions until the operator resets the system.

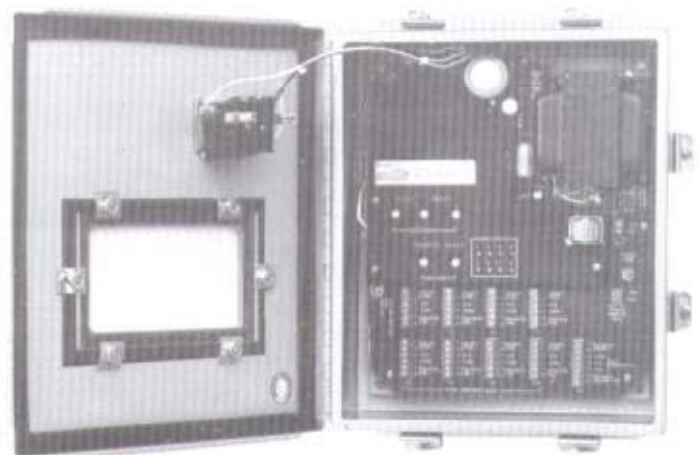

MODEL 563A

The Model 563A is a microprocessor based monitor and control unit. The solid-state electronic system will "sort out" false signals received by the Vibraswitch so that alarm and/or shutdown will not result from false transient disturbances. It has field adjustable Start Delay from 0 to 999 seconds and Monitor Delay of 0 to 99 seconds.

Eight LED indicators, viewable through the window on the instrument door, are provided for visual indication to determine which Vibraswitch detected the excessive vibration and triggered the alarm and/or shutdown.

Optional enclosures are weather-proof NEMA 4 or explosion-proof for Class I, Division 1, Groups C & D hazardous locations. The unit is designed for use with one to eight Vibraswitch Models 365 or 366. Power supply options are 120 VAC, 50/60 Hz.; 240 VAC, 50/60 Hz.; 24 VDC or 48 VDC.

Velocity-Acceleration Vibration Monitor

MODEL 566



The Robertshaw Model 566 Vibration Monitor is a solid state instrument that encompasses a variety of functions all in one unit. Vibration can be monitored in either velocity or acceleration. The standard ranges are 0 to 1.5 inches/second or 0 to 3 inches/second when sensing velocity and 0 to 5 G's or 0 to 10 G's when sensing acceleration. A 4-20 maDC output is standard.

The Model 566 includes two solid state Triacs (2 amp @ 120/240 VAC) which can be operated in a N.O. or N.C. configuration. Alarms are capable of being latched or non-latched (ON-OFF). A time delay function is also a standard feature and is adjustable from 0.5 to 15 seconds. LED setpoint indicators are provided to indicate the alarm condition. Options include P/S (120 or 240 VAC) and remote sensor. The remote sensor can be located up to 1,000 feet away using only a standard ungrounded pair of twisted wire.

The Model 566 enclosure is designed to be weatherproof and explosion-proof. The enclosure rating is NEMA 4 and Class I, Division 1, Group C and D; Class II, Division 1, Group E, F and G. Housing for the remote mounted transducer has the same rating plus Class I, Group B.

Note that on the remote sensor unit the connection from the Model 566 to the remote sensor need only be two ungrounded wires.

PRINCIPLE OF OPERATION

The Model 566 employs totally solid state circuitry. Velocity or acceleration sensing mode of operation is field selectable without loss of accuracy. The unit is factory calibrated in all ranges. Two alarm setpoints are standard plus use of a built-in 4-20 maDC output.

A machine power monitor input, such as 120 or 240 VAC is provided to enable the monitor delay and analog output circuitry when the monitored unit is turned on. The time delay period can be set in the field up to 15 seconds.

The indicators (LED) will illuminate when the setpoints are reached. They are electrically connected in the circuit prior to the time delay to allow for field calibration of the alarm setpoints without shutting down the machine being monitored.

- Alarm # 1 - Operates with adjustable time delay (0.5-15 Sec.). When the vibration signal continues to exceed the setpoint for as long as the time delay setting, the alarm actuates.
- Alarm #2 - Actuates when vibration signal exceeds setpoint. No time delay function available.
- Latch Disable - Disables alarm latches. When on, alarms reset automatically when vibration level returns to normal.

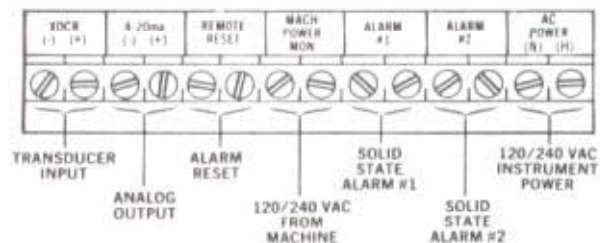

CUSTOMER CONNECTIONS

**ELECTRONIC VIBRASWITCHES
WITH BUILT-IN TIME DELAY SYSTEMS**

models 375A·376A



MODEL 375A
Explosion-Proof
FM Approved



The Model 375A and 376A detectors are identical in outside dimensions and appearance to the famous Model 365 and 366. However, these instruments include built-in solid state electronic circuitry for start and/or monitoring time delay functions for prevention of false shutdowns due to transient vibrations.

The 375A is FM approved for Class I, Division 1, Groups C & D; Class II, Division 1, Groups E, F & G; and Class III, Div. 1 hazardous locations.

The Electronic Vibraswitch offers complete vibration protection in a single compact package. It is available at low initial cost and saves both time and labor in its installation. The instrument is available in Start Only Time Delay, Monitor Only Time Delay or with both Start and Monitor Time Delay. For the Start Delay Only version the output switching is SPDT rated 5 amps at 120 or 240 VAC. The output switching for the Monitor Only and Start and Monitor versions is a solid state optically isolated TRIAC which will supply up to 2 amperes at 120 VAC 50/60 Hz. to an external load.

HOW THE UNIT FUNCTIONS

Start Delay Only models hold the Vibraswitch armature in its reset position for a preset starting time after application of supply voltage to the instrument. This prevents the Vibraswitch from tripping out during machine startup. Fixed timing periods of 15, 30, 60 or 90 seconds are available. After the time period, the Vibraswitch functions as normal with shutdown or alarm functions provided by utilizing the SPOT switch contacts in the Vibraswitch.

Monitor Delay Only models prevent nuisance shutdowns due to tripping out of the Vibraswitch during high level short term transient vibration conditions by automatically resetting the Vibraswitch. Under continuing high vibration, the Vibraswitch trips, is immediately reset, trips out again, it resets again, etc. This "sampling" process continues until the time delay period has elapsed, after which the unit remains "tripped" out. An AC output by means of an optically isolated solid state TRIAC switch can be used for either alarm or shutdown. The solid state switching mode can be changed by means of a solderable link to the equivalent of an NO (for alarm) or NC (for shutdown) electrical contact.



MODEL 376A
Weather Proof

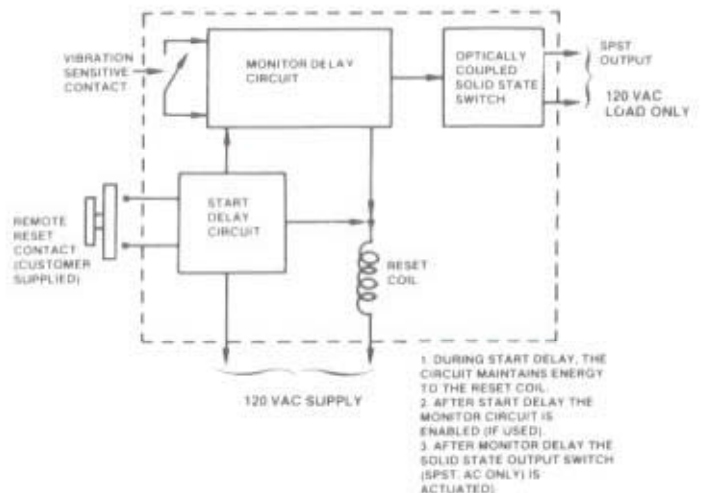

Figure 7
Block Diagram: Start and Monitor Electronic Vibraswitch

Refer to Figure 7 showing the basic block diagram of the Electronic Vibraswitch for the functional operation of the unit. For dimensional data, refer to page 6 on Models 365/366.

INSTALLATION AND APPLICATIONS

The Vibraswitch must be mounted on a flat surface so that all four corners are in rigid contact with the mounting surface. If the machine has irregular surfaces, a heavy steel mounting plate can be used, but it must be rigidly attached to the machine. Typically, one-half inch steel plate is satisfactory and it should be made as small as is consistent with the size of the Vibraswitch base to reduce resonance effects. The vibration sensitive axis of the Vibraswitch is perpendicular to its base; therefore it must be mounted in the correct plane to detect the vibratory motion for which protection is desired.

A preferable location is in line with rotating main shafts and as near bearings as is possible. Typical machines requiring protection are pumps (both reciprocating and centrifugal), fans, blowers, compressors, gear boxes, mills, turbines, etc.

model 368

VIBRATION PROTECTION USING PNEUMATIC POWER

The Robertshaw Model 368 Vibraswitch is a pneumatically powered detector for use on machines where electrical power is not available. This instrument is particularly well suited to installation in hazardous (explosive) areas (even in extreme hazard such as hydrogen atmospheres) since only compressed air is required for its alarm and/or control operation. It does not require explosion-proof housings. The instrument is also well suited for applications at pipeline compressor stations and skid-mounted compressors since it will operate on either natural gas or compressed air.

The Model 368 is identical to the Model 365/366 Vibraswitch in its principle of operation as described in this bulletin; refer to Figure 4 for its basic operation.

OPERATION OF THE PNEUMATIC VIBRASWITCH

When the instrument is subjected to vibration perpendicular to the base, the resultant vibratory inertial force, aided by the adjusting spring, pulls the armature away from the hold-down magnet. Magnitude of this inertial force is proportional to the mass of the armature and the acceleration component of the vibratory motion. $F = MA$ where force (F) is equal to mass (M) times acceleration (A). Refer to Figure 8 for the basic pneumatic diagram of the Model 368 Vibraswitch.

When the peak acceleration exceeds the set-point level, the armature breaks away from the stop pin, moving the trip plunger upward to open the pneumatic valve, which is normally closed maintaining a 20 psig pressure; on opening, the inlet (controlled) line pressure drops to 3 psig or lower.

The pneumatic valve vents into the sealed cover and out the exhaust (vent) port. The decrease in control pressure is used to actuate a pneumatic relay which will initiate alarm or shutdown of the malfunctioning equipment.



**MODEL 368
PNEUMATIC VIBRASWITCH**

Operation of the reset valve will apply pressure to the reset piston, returning the Vibraswitch armature to the reset position. Returning the three-way reset valve to its normal position vents air from the reset piston and returns the reset piston to its normal position. Manual reset of the armature is also provided by an external reset button.

TECHNICAL DATA

The cover is made of high-impact ABS plastic and the base is 360 (Cu Free) aluminum. The unit is completely gasketed in order to provide an air-tight seal to atmosphere so that natural gas may be used to operate the pneumatic valve assembly. When operated on natural gas, the external pneumatic relay must be compatible to natural gas and both the Vibraswitch and the relay must have their vents connected to piping that will vent into a safe area. The supply pressure must be a minimum of 15 psig and a maximum of 35 psig. The set-point range is adjustable from 0 to 4.5 G's. The sensitive axis to vibratory motion is perpendicular to its base.

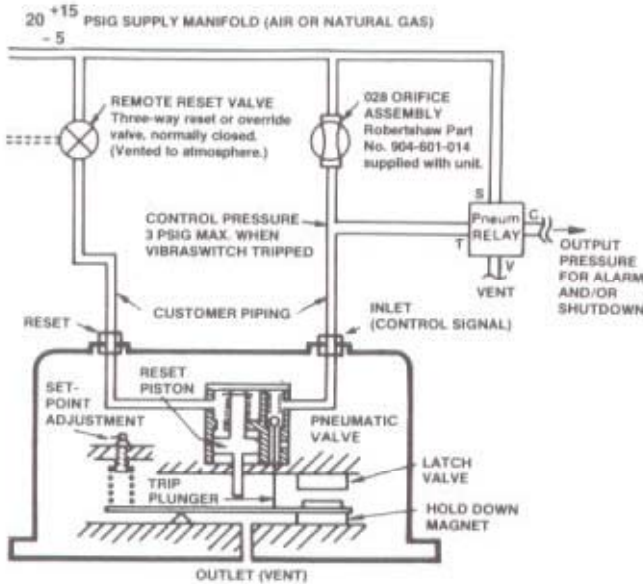

**Figure 8
Basic Pneumatic Diagram — Model 368**

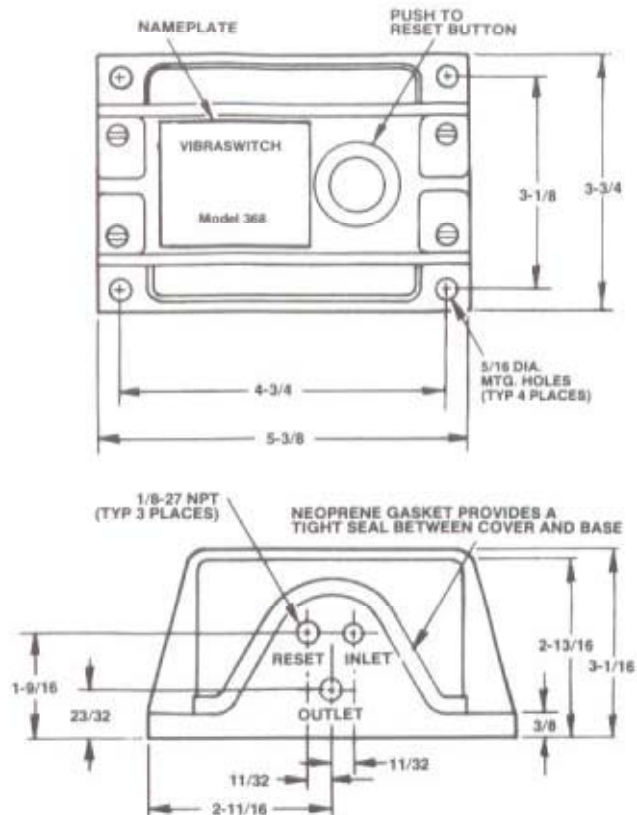

Dimension Data — Model 368



Cable Sold Separately

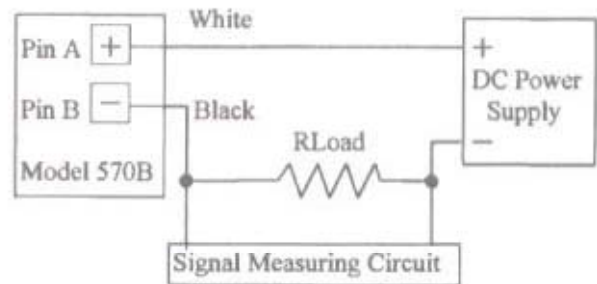

TYPICAL 570B CIRCUIT

MODEL 570B AND MODEL 571A LOOP POWERED STUD MOUNTED VIBRATION TRANSMITTERS

The model 570B is a 10-30 vdc loop powered vibration transmitter which provides a 4-20 mADC output proportionate to vibration. The transmitter is available with a measurement range of either 0-5 g, 0-10 g or 0-20 g peak acceleration, or 0-0.5 IPS, 0-1 IPS or 0-2 IPS peak velocity; and the frequency range is 2 Hz to 2 KHz. This rugged compact unit provides continuous monitoring of machine vibration for trending, alarm and/or shutdown when used with a PLC, computer, DCS, data logger or current relays. The enclosure is 316L stainless steel, NEMA 4X (hermetically sealed), and meets IP68.

Installation is simple and no calibration is required. A 1/4-28 stud is provided for mounting. The unit has a 2 pin connector and mates with a standard MIL-C-5015 2 socket connector with a splash proof connection. Optional cable assemblies are available in lengths of 16, 32, 64 and 112 feet.

The model 571A is a 14-30 vdc intrinsically safe version of the model 570B. It is CSA Certified for use in the USA and Canada for Class I, Division 1, Groups A, B, C & D; T3C; when connected to an approved barrier. For non-incendive environments a safety barrier is not required. It is also ATEX Certified EEx ia IIC T3 for use in Europe when connected to an approved barrier.

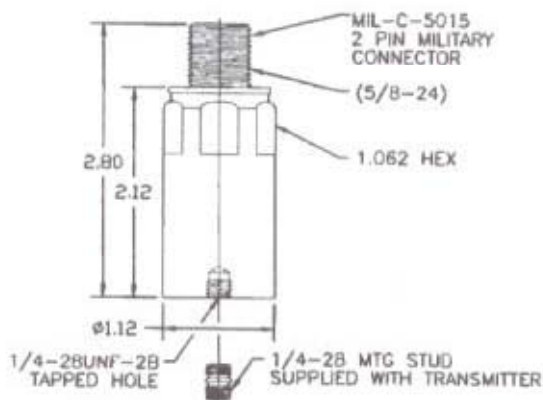

MODELS 570B and
571A

typical vibraswitch installations

The following line drawings show the recommended locations for mounting the Vibraswitch on various machines.

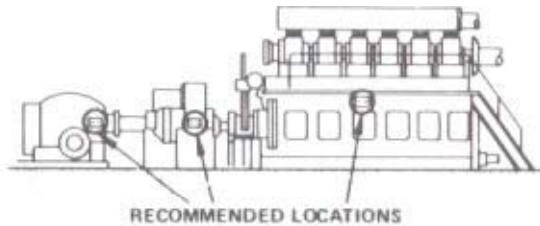

ENGINE - GEAR
CENTRIFUGAL COMPRESSOR

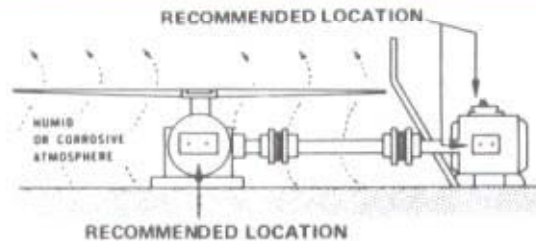

COOLING
TOWER FAN

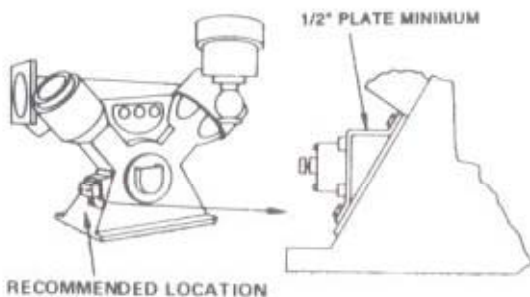

RECIPROCATING
COMPRESSOR "Y" TYPE



HORIZONTAL OPPOSED
RECIPROCATING COMPRESSOR

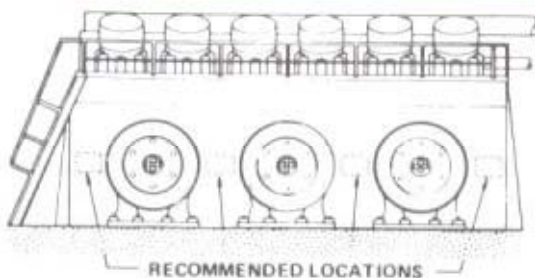

DIESEL ENGINE
COMPRESSOR UNIT

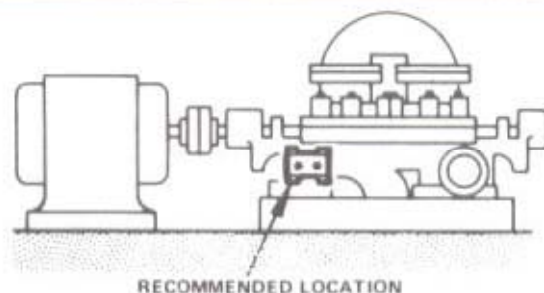

CENTRIFUGAL
PUMP

Robertshaw

U.S.A. and Canada
Robertshaw Industrial Products Division
1602 Mustang Drive
Maryville, TN 37801
Telephone: (865) 981-3100 Fax: (865) 981-3168
<http://www.robertshawindustrial.com>

YOUR ROBERTSHAW REPRESENTATIVE IS: