

Level-Lance™ Model 5400A

GENERAL DESCRIPTION

The ROBERTSHAW Level-Lance Model 5400A is a microprocessor based, multi-point On-Off capacitance type level detection system. Utilizing the Pulse Frequency Modulation (PFM) method of signal transmission ensures that accuracy, repeatability and longevity are enhanced over level systems using conventional analog transmission schemes. The PFM transmitter, normally mounted directly on the sensing probe, requires no calibration or adjustments of any kind. The control unit can be mounted up to one mile from the PFM transmitter without requiring any special type of interconnecting wire or cable. Two wires are all that is required. The PFM transmitter does not require any primary power because it receives its operating power from the control unit over the same two wires used to transmit the level signal.

The PFM transmitter is also designed to provide electrostatic protection at the probe input. It transmits a frequency modulated pulse signal to the microprocessor based control unit. The variation in the frequency of the pulse is proportional to the product level on the sensing probe. The microprocessor in the control unit receives the pulse and processes it to extract the level information. The microprocessor then compares this level information to the "AUTO-SET" calibration data stored in the non-volatile memory. When the level data coincides with this previously stored data, the appropriate output relay is either activated or deactivated, to give the desired control action. The total system design has been optimized to yield the highest possible levels of both EMI and RFI rejection.

The Model 5400A Level-Lance is calibrated by means of the "AUTO-SET" feature. This feature permits all calibration of the unit to be done by the simple act of pushing a button.

The Model 5400A Level-Lance is designed with plug-in type relay output modules to allow for easy configuration changes. Relay outputs can be added or removed in the field by the user. The control unit has the capability of having up to four relay output modules installed. The PFM input is optically coupled for better noise immunity.



Probe shown for illustration only. Not included.

FEATURES AND BENEFITS

- **Microprocessor Based**
- **"Auto-Set" (Pushbutton Calibration)**
- **Modular Construction**
- **Multi-Point Control (1-4) Relays, Using Only One Sensor (Probe)**
- **Economical, Cost Much Less Than 4 Individual Controls**
- **Up To 1 Mile Signal Transmission Between Probe/PFM & Control Unit Using 2 Plain Wires**
- **Independent Time Delay and Adjustable Differential For EACH Relay**
- **Lead/Lag Feature For Automatic Pump Alternation**
- **Heavy Duty 10 Amp Relays**
- **Self-Diagnostics With LED Failure Indication**
- **Designed For Maximum EMI and RFI Rejection**
- **Optical Isolation Between PFM and Controller**
- **Non-Volatile Calibration Memory**
- **Optional Indicating Lights**
- **Optional AC or DC Supply Power**
- **Optional Enclosures (NEMA 4, 4X or Explosion-Proof)**
- **UL and c-UL Listed**

GENERAL DESCRIPTION - continued

Each relay output can be individually configured for:

- A) Fixed minimum or adjustable differential (deadband).
- B) High or Low level fail safe.
- C) Adjustable time delay.

These selections are made by means of miniature selector switches located on the individual relay output modules. All relay output module functions are totally independent of other relay output modules.

An additional switch located on the main (microprocessor) board allows for selection of the overall operating mode as follows:

- A) Normal operation.
- B) Load sharing. This mode permits the sequential operation of two to four pumps or motors, alternated or rotated to prolong their life.
- C) Test (self diagnostics). LED's indicate transmitter (PFM) or receiver (RCVR) failure or calibration (CAL) error.

OPTIONS

Indicating Lights (one red and one green for each relay) mounted on the receiver. This allows the user to glance at the instrument and tell where the product level is in relation to the trip points.

Optional enclosures are also available for both corrosive (NEMA 4X) and hazardous (explosion-proof) locations.

The standard models are switch selectable for either 120 or 240 VAC operation and an option is available for 18 to 30 VDC operation.

SPECIFICATIONS

ELECTRICAL/ELECTRONIC:

Supply Voltage

Standard - 120/240 VAC \pm 10%, 50/60 Hz
Optional - 18 to 30 VDC

Supply Power

Exp-proof w/lights ... 48 Watts Max
All other models 20 Watts max

Control Range 0 to 3000 pF

Adjustable Differential 0.2 pF to 100% of
Control Range

Fixed Differential 0.1 pF

Adjustable Time Delay 0 to 99 seconds

Ambient Temperature Effect

\pm 0.005 pF/deg F or \pm 0.01%/deg F,
whichever is greater

Supply Variation Effect None

Linearity \pm 0.5%

Resolution 0.1 pF

Repeatability \pm 0.1 pF

Relay Output

Electro-Mechanical, DPDT
10 A @ 30 VDC, 120 VAC, 240 VAC RES;
5 A @ 120 VAC IND;
3 A @ 240 VAC IND;
1/3 HP @ 120 VAC, 240 VAC

Maximum Distance Between Probe
and Transmitter Fifteen (15) feet

Type of Interconnecting Cable

Coaxial, RG-62/U, rated 80° C minimum

Maximum Distance Between Transmitter and
Controller One (1) mile

Type of Interconnecting Cable

Two (2) wires, twisted pair in grounded metal
conduit or twisted, shielded pair in non-metallic
conduit.

14 AWG Maximum rated 80° C minimum

INTRINSIC SAFETY:

PFM Transmitter and Probe

Without the addition of a barrier

UL Certified for use in the United States as intrinsically safe for Class I, Division 1, Group A, B, C & D; Class II, Division 1, Group E, F & G and Class I, Zone 0, Group IIC hazardous locations when connected as shown on drawing 907GA826. Maximum distance between controller and PFM transmitter is 333 feet.

c-UL Certified for use in Canada as intrinsically safe for Class I, Division 1, Group C & D; Class II, Division 1, Group E, F & G and Class I, Zone 0, Group IIB hazardous locations when connected as shown on drawing 907GA826. Maximum distance between controller and PFM transmitter is 1000 feet (305 M).

With an added barrier

UL and c-UL Certified as intrinsically safe for Class I, Division 1, Group A, B, C & D; Class II, Division 1, Group E, F & G and Class I, Zone 0, Group IIC hazardous locations when connected as shown drawing 907GA811. Maximum distance between barrier and PFM transmitter is determined by the specifications of the interconnecting cable as specified on drawing 907GA811. Maximum distance between the controller and the PFM transmitter is one mile.

Note: Intrinsic safety ratings specified above apply only when using the standard PFM transmitter, Designations 1 through 4 in table 4. When employing a different PFM transmitter, refer to the specifications of that PFM transmitter for the intrinsic safety ratings.

AGENCY CERTIFICATIONS:

UL Listed File E164999

c-UL Listed File E164999

Note: Agency Certifications apply only when using the standard PFM transmitter, Designations 1 through 4 in table 4.

ENVIRONMENTAL:

Ambient Temperature -30° to +140° F
(-34° to +60° C)

Storage Temperature -40° to +158° F
(-40° to +70° C)

Relative Humidity ... 0 to 95% (non-condensing)

Vibration ± 2 G, 10 to 200 Hz

Shock 75 G for 11 msec
without permanent damage

ENCLOSURE:

Controller

Raintight -

Standard - Polyurethane painted steel, Type 4

Optional - Fiberglass, Type 4X

Optional - Stainless steel, Type 4X

Explosion Proof - Cast aluminum, UL Listed Class I, Group D; Class II, Group E, F & G; Class I, Zone 1, Group IIA c-UL Listed Class I, Group C & D; Class II, Group E, F & G; Class I, Zone 1, Group IIB

PFM Transmitter

Raintight -

Standard - Polyurethane painted cast aluminum, Type 4

Optional - Gray epoxy painted cast aluminum, Type 4X

WEIGHTS(approximate):

Controller, steel 20 lbs (9.07 kg)

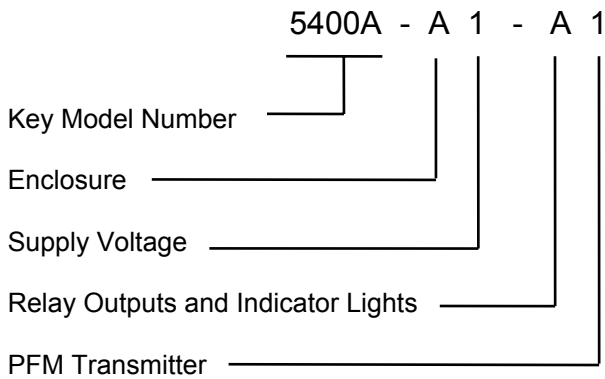
Controller, fiberglass 12 lbs (5.44 kg)

Controller, stainless steel21 lbs (9.53 kg)

Controller, explosion proof 51 lbs. (23.13 kg)

PFM Transmitter2.8 lbs. (1.27 kg)

MODEL IDENTIFICATION:



KEY MODEL NUMBER

Designation	Description
5400A	Multiple output microprocessor based On-Off level controller and PFM Transmitter.

TABLE 1 - ENCLOSURE

Designation	Description
A	NEMA 4, Raintight, Steel
B	NEMA 4X, Raintight, Fiberglass
C	NEMA 4X, Raintight, Stainless Steel
D	NEMA 7CD & 9EFG, Explosion Proof, Cast Aluminum

TABLE 2 - SUPPLY VOLTAGE

Designation	Description
1	18 - 30 VDC
2	120/240 VAC, ± 10%, 50/60 Hz

TABLE 3 - RELAY OUTPUTS

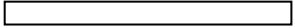

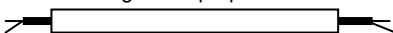

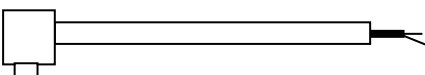





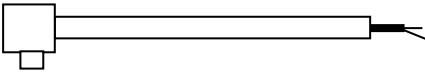


Designation	Description
A	One Relay Output w/o Indicator light
B	Two Relay Outputs w/o Indicator lights
C	Three Relay Outputs w/o Indicator lights
D	Four Relay Outputs w/o Indicator lights
E	One Relay Output with Indicator light
F	Two Relay Outputs with Indicator lights
G	Three Relay Outputs with Indicator lights
H	Four Relay Outputs with Indicator Lights

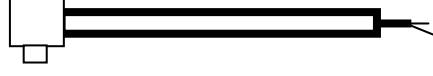


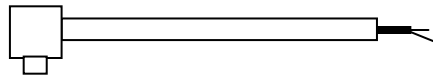

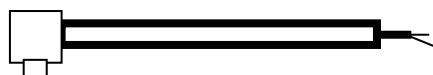

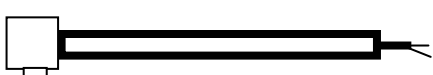
TABLE 4 - PFM TRANSMITTER

Designation	Description
0	None - Controller Only
1	Standard PFM Transmitter, Probe Mounted, NEMA 4
2*	Standard PFM Transmitter, Remote Mounted, NEMA 4
3	Standard PFM Transmitter, Probe Mounted, NEMA 4X
4*	Standard PFM Transmitter, Remote Mounted, NEMA 4X

* Maximum distance between probe and remote mounted PFM Transmitter is 15 feet. Installation requires coaxial cable, conduit and conduit outlet box listed under ACCESSORIES.

ACCESSORIES:

Part Number	Description
032KC190-XX*	Conduit with 1/2" NPT connections, flexible, liquid tight, general purpose 
032KC600-XX*	Coax cable 
032KC650-XX*	Coax cable with general purpose conduit 
032KC700-XX*	Coax cable with NEMA 4 conduit outlet box** 
032KC710-XX*	Coax cable with general purpose conduit and NEMA 4 conduit outlet box 
032KC720-02	Coax cable, 2 ft long, with explosion proof conduit and NEMA 4 conduit outlet box** 
032KC720-05	Coax cable, 5 ft long, with explosion proof conduit and NEMA 4 conduit outlet box** 
032KC720-08	Coax cable, 8 ft long, with explosion proof conduit and NEMA 4 conduit outlet box** 
032KC720-10	Coax cable, 10 ft long, with explosion proof conduit and NEMA 4 conduit outlet box** 
032KC800-XX*	Coax cable with NEMA 4X epoxy painted conduit outlet box** 
032KC810-XX*	Coax cable with general purpose conduit and NEMA 4X epoxy painted conduit outlet box 
032KC820-02	Coax cable, 2 ft long, with explosion proof conduit and NEMA 4X epoxy painted conduit outlet box** 
032KC820-05	Coax cable, 5 ft long, with explosion proof conduit and NEMA 4X epoxy painted conduit outlet box** 

Part Number	Description
032KC820-08	Coax cable, 8 ft long, with explosion proof conduit and NEMA 4X epoxy painted conduit outlet box** 
032KC820-10	Coax cable, 10 ft long, with explosion proof conduit and NEMA 4X epoxy painted conduit outlet box** 
032KC900-XX*	Coax cable with NEMA 4X stainless steel conduit outlet box** 
032KC910-XX*	Coax cable with general purpose conduit and NEMA 4X stainless steel conduit outlet box 
032KC920-02	Coax cable, 2 ft long, with explosion proof conduit and NEMA 4X stainless steel conduit outlet box** 
032KC920-05	Coax cable, 5 ft long, with explosion proof conduit and NEMA 4X stainless steel conduit outlet box** 
032KC920-08	Coax cable, 8 ft long, with explosion proof conduit and NEMA 4X stainless steel conduit outlet box** 
032KC920-10	Coax cable, 10 ft long, with explosion proof conduit and NEMA 4X stainless steel conduit outlet box** 
909SD029**	Conduit outlet box, NEMA 4
909SD029-50**	Conduit outlet box, NEMA 4X, epoxy painted
909SD029-51**	Conduit outlet box, NEMA 4X, stainless steel

* Substitute the desired cable length, in feet, for "XX" to complete Cable Part Number.
Maximum cable length is 15 feet.
Coax cable is Teflon insulated, maximum temperature 350° F, with terminations for attachment to probe and PFM Transmitter.
** Conduit outlet boxes are explosion proof.

DIMENSIONS

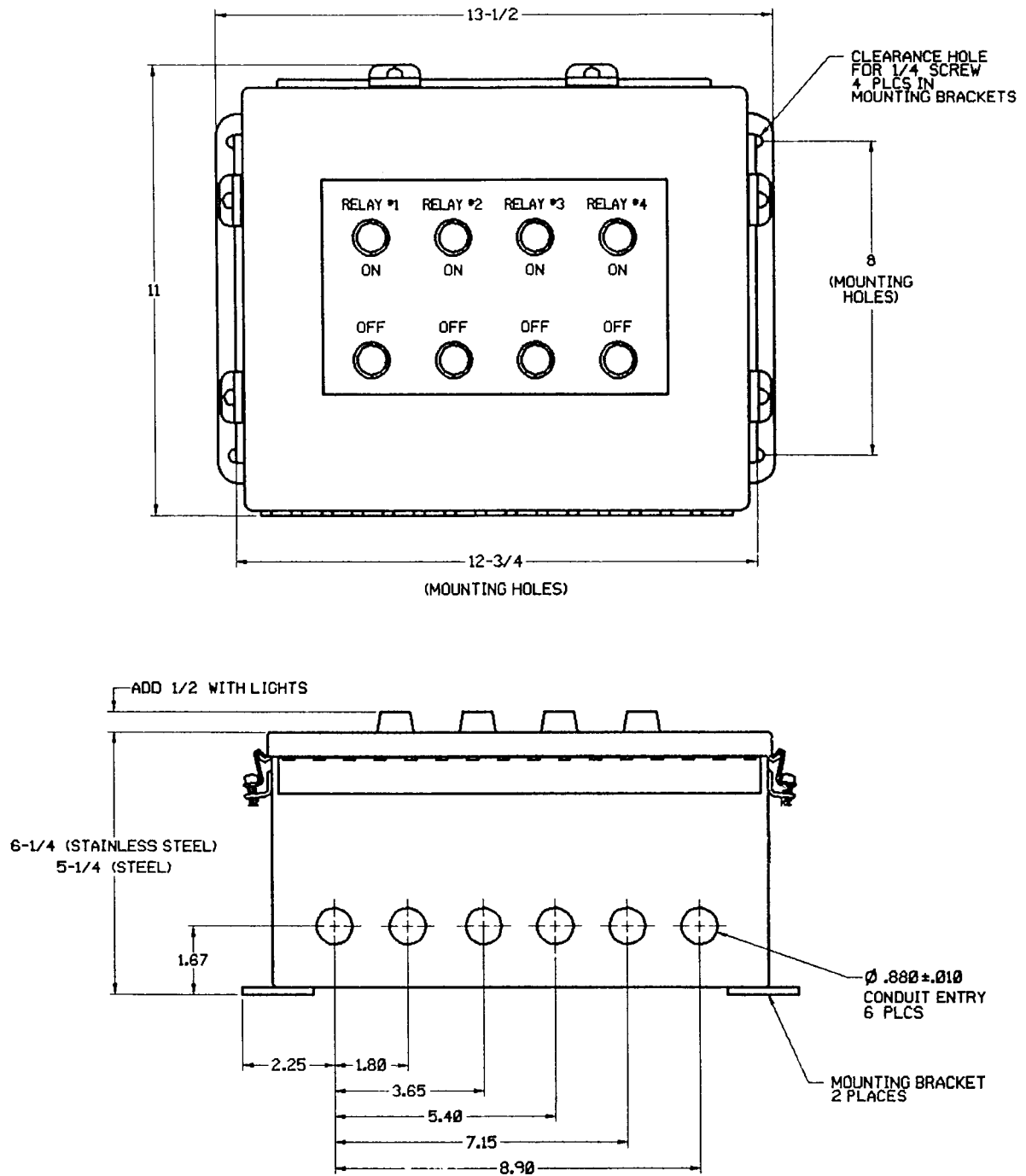


Figure 1
NEMA 4 Painted Steel Enclosure and
NEMA 4X, Corrosion Resistant Stainless Steel Enclosure

DIMENSIONS – continued

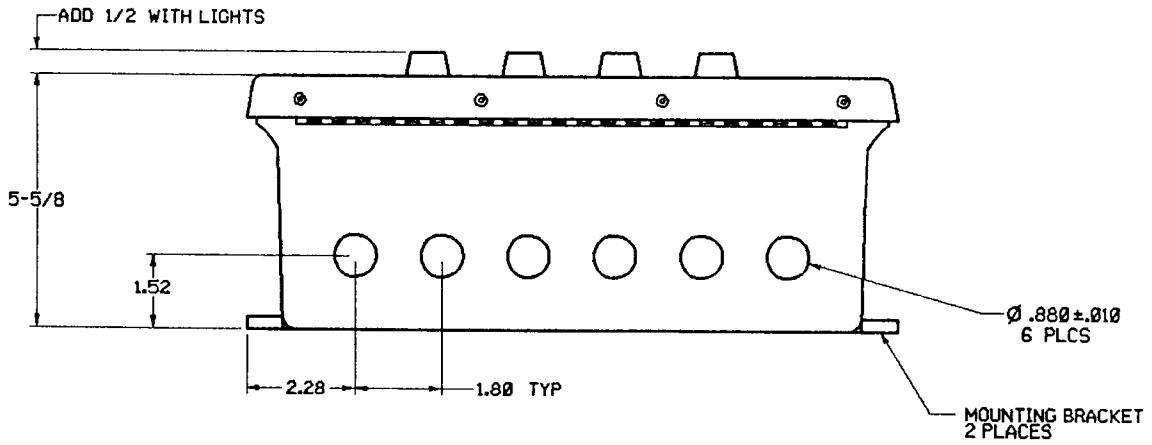
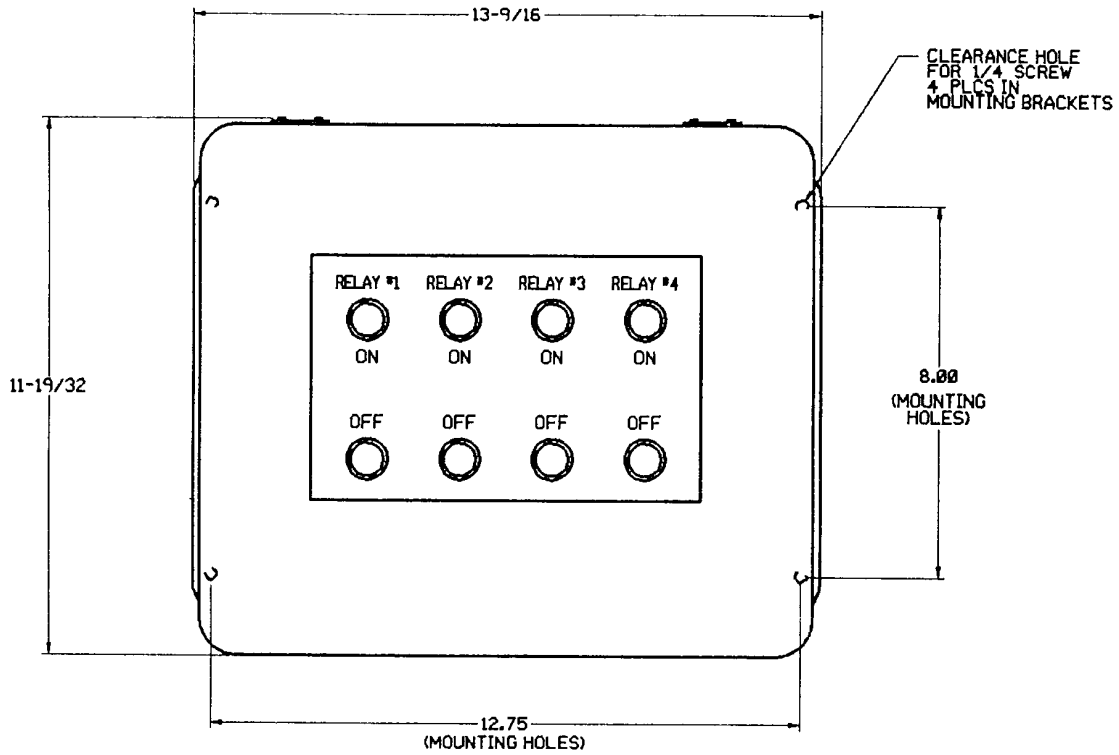


Figure 2
NEMA 4X, Corrosion Resistant Fiberglass Enclosure

DIMENSIONS – continued

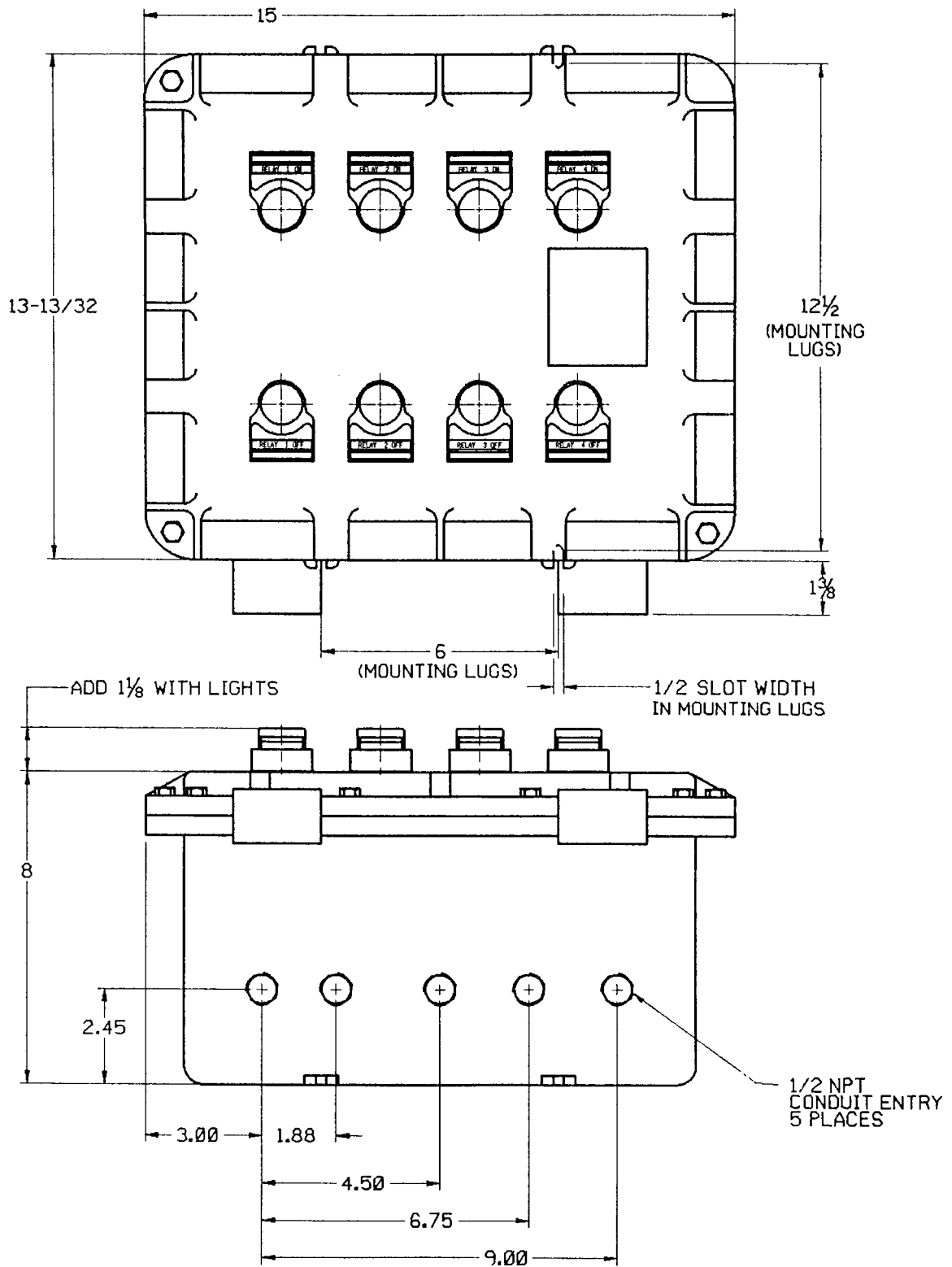
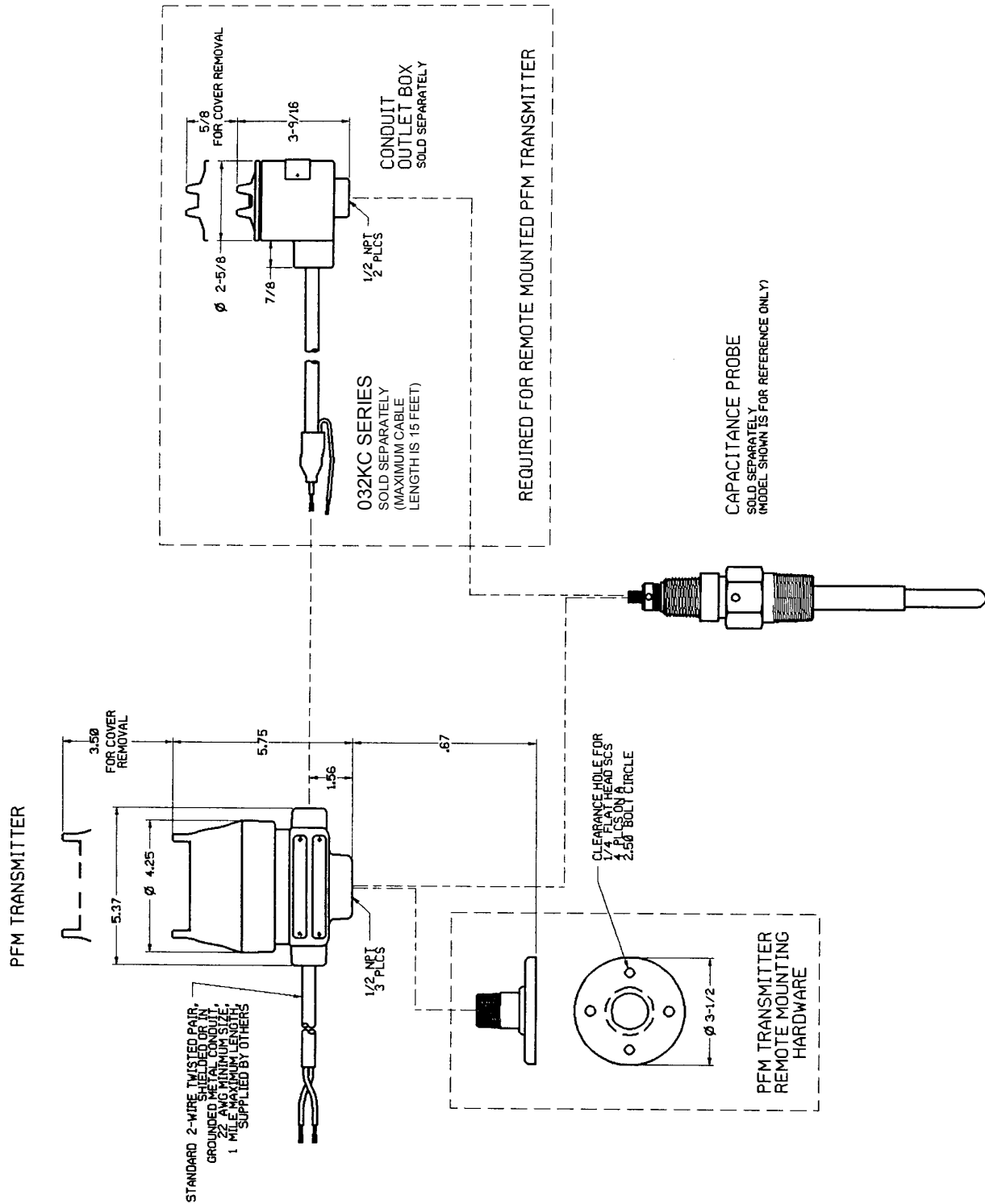


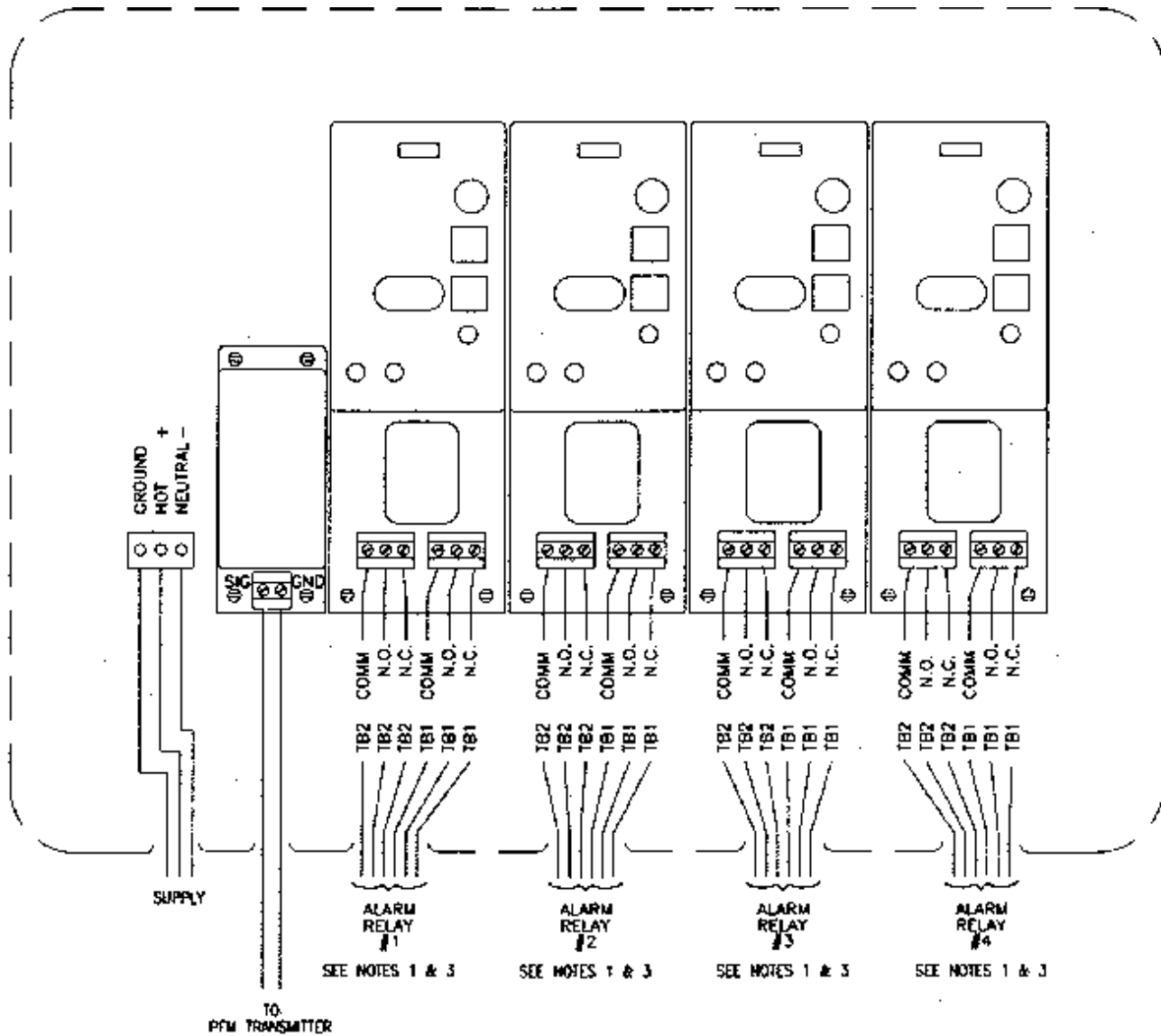
Figure 3
NEMA 7CD and NEMA 9EFG
Explosion-Proof, Cast Aluminum, Enclosure

DIMENSIONS - continued



**Figure 4
PFM Transmitter**

ELECTRICAL CONNECTIONS

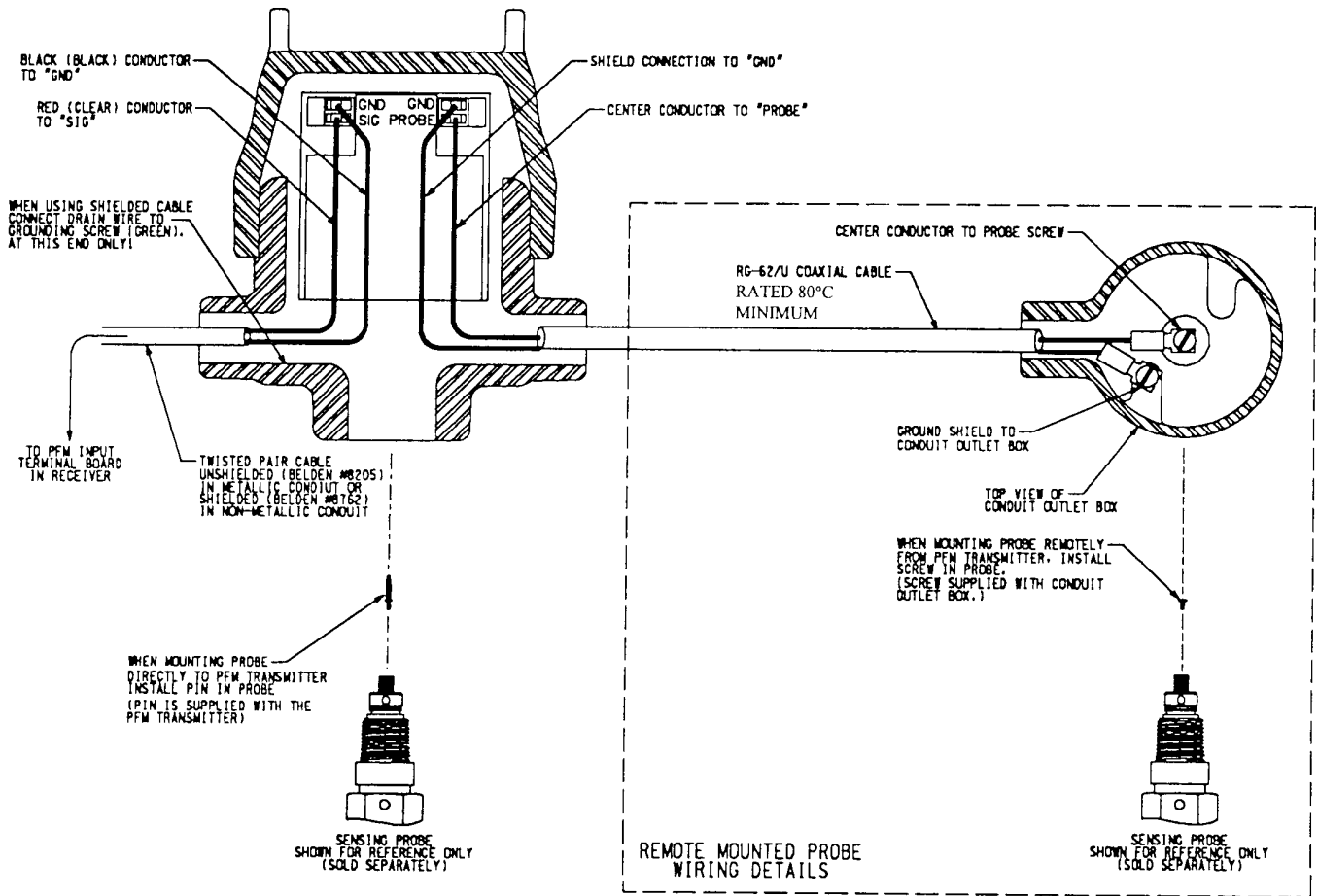


NOTES:

1. RELAYS ARE NORMALLY ENERGIZED AND BECOME DE-ENERGIZED WHEN LEVEL OR PROCESS REACHES CONTROL POINT.
2. ON EXPLOSION-PROOF MODELS:
WHEN INDICATOR LIGHTS ARE SUPPLIED, TB1 ON EACH RELAY BOARD IS USED TO OPERATE ITS RESPECTIVE INDICATOR LIGHT. TB1 IS FACTORY WIRED TO THE INDICATOR LIGHTS.
3. TIGHTEN ALL FIELD WIRING SCREWS TO 5 POUND-INCHES (0.56 N/m).
4. FIELD WIRING TO THE CONTROL UNIT TO BE 14 AWG MAXIMUM, RATED 80° C MINIMUM.

**Figure 5
Electrical Connections – Controller**

ELECTRICAL CONNECTIONS - continued



NOTES:

1. TIGHTEN ALL FIELD WIRING SCREWS TO 5 POUND-INCHES (0.56 N/m).

Figure 6
Electrical Connections – PFM Transmitter

Robertshaw

U.S.A. and CANADA

Robertshaw Industrial Products Division
1602 Mustang Drive
Maryville, Tennessee 37801
Phone: (865) 981-3100 Fax: (865) 981-3168
<http://www.robertshawindustrial.com>

Exports

Invensys Appliance Controls
1701 Byrd Avenue
P.O. Box 26544
Richmond, Virginia 23261-6544
Phone: (804) 756-6500 Fax: (804) 756-6561

Q-4160 (10/03)

Printed in U.S.A.

